

American Security

Gun Safes

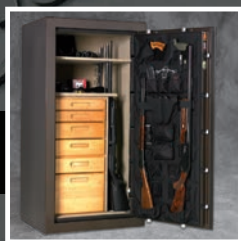

Residential Safes



Luxury Fire & Burglary Safes

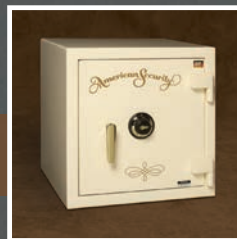

Cash Management, Deposit & Smart Safes



U.L. Listed High Security

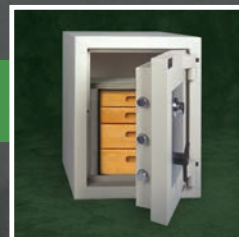

Pharmacy & Narcotics Safes



Commercial Safes



Locks



Product Catalog 2014

TABLE OF CONTENTS



American Security Products Company has been dedicated to manufacturing high quality, high security safes since 1946. We offer an extensive product line of over 400 standard models of burglary and fire resistant safes in every insurance classification from "B" rate to Underwriter's Laboratories TL-15 and TL-30.

AMSEC is the largest and most respected safe manufacturer in the industry because:

- Our dedicated customer service representatives care about you.
- Fully staffed service department networked with thousands of factory trained technicians.
- Our quality control department assures that the products we build are the finest in the industry.
- State-of-the-art computer controlled manufacturing equipment helps us meet demanding deadlines and keeps us on the leading edge of technology.
- We are located in a major West Coast distribution point with direct access to all major domestic and international freight services.
- We specialize in developing custom safes to meet specific cash handling requirements for banks, restaurants, supermarkets, convenience stores and many other industries.
- Our engineering and design department is fully staffed and features the most advanced CAD system for rapid creation of sales drawings, design modifications and precise manufacturing blue prints.

For superior asset protection there is only one name you can trust for quality, service and reliability...**AMSEC**.

AMSEC reserves the right to incorporate any improvements and alter any specifications without prior notice. AMSEC reserves the right to update products as necessary, AMSEC is not responsible for typographical errors.

WALL SAFES	3
SQUARE DOOR FLOOR SAFES	4
<i>BRUTE, SUPER BRUTE AND MINI BRUTE SERIES</i>	4
FLOOR SAFES	6
<i>STAR® ROUND LIFT-OUT DOOR</i>	6
<i>STAR® RECTANGULAR BODY, ROUND LIFT-OUT DOOR</i>	7
<i>MAJOR® ROUND LIFT-OUT DOOR</i>	7
UNDERCOUNTER SAFES	8
CASH MANAGEMENT SAFES	9
<i>RETAIL MONEY MANAGER SAFE</i>	9
<i>CASHWIZARD® BILL READER SAFES</i>	10
DEPOSITORY SAFES	
<i>BWB SERIES - WIDE BODY CASH CONTROL</i>	12
<i>DS SERIES - "B" RATE ROTARY AND FRONT LOADING</i>	13
<i>MONEY MANAGER</i>	14
"B" RATE SECURITY SAFES	
<i>BWB SERIES AND MS1414</i>	15
IMPORTED U.L. LISTED 1-HR FIRE SAFES	16
UL SERIES	
<i>U.L. LISTED 2-HOUR FIRE AND IMPACT SAFES</i>	17
BF® SERIES	
<i>U.L. LISTED FIRE RATED BURGLARY SAFES</i>	18
COMMERCIAL SECURITY SAFES	
<i>CSC SERIES COMPOSITE SAFES</i>	19
GUN SAFES	
<i>NEW! HS SERIES - HIGH SECURITY RFX & RF MODELS</i>	20
<i>THE BF® SERIES GUN SAFES</i>	21
<i>SF SERIES - SIXTY MINUTE FIRE</i>	22
<i>FV SERIES - 45 MINUTE FIRE</i>	23
<i>TF SERIES - THIRTY MINUTE FIRE</i>	24
DEFENSE VAULT	25
VAULT DOOR	25
GUN SAFE ACCESSORIES	26
HANDGUN SECURITY	26
STORAGE OPTIONS	27
HOME SECURITY	
<i>AM SERIES HOME SECURITY SAFES</i>	28
<i>ELECTRONIC SECURITY SAFES</i>	28
ELECTRONIC SAFES	29
"B" AND "C" RATE SECURITY CHESTS	
<i>BLB AND BLC SERIES</i>	30
DXE / DXF AND CDXE / CDXF U.L. LISTED	
<i>TL-15 & TL-30 MONEY CHESTS</i>	31
ACF TL-30 SERIES	32
<i>U.L. LISTED FIRE RATED MONEY CHEST</i>	32
<i>U.L. LISTED FIRE RATED DEPOSITORY SAFE</i>	33
<i>AMVAULTX6 TL-30X6 HIGH SECURITY SAFE</i>	33
AMVAULT TL-30 AND TL-15	
<i>FIRE RATED COMPOSITE SAFES</i>	34
<i>SAFE SPECIFICATIONS</i>	35
PHARMACY / NARCOTICS SAFES	36
TELLER LOCKERS	37
CUSTOM SAFES	37
OPTIONAL EXTRAS	38
MECHANICAL LOCKS AND KEY LOCKS	39
ELECTRONIC LOCKS	40
<i>ELECTRONIC LOCK COMPARISON CHART</i>	40
<i>AMSEC SAFEWIZARD®</i>	41
<i>NEW! ESLAUDIT</i>	42
<i>ESL5 AND ESL15</i>	42
<i>AMSEC ESLXL SERIES</i>	43
<i>SARGENT AND GREENLEAF</i>	44
<i>KABA-MAS</i>	44
<i>LAGARD ELECTRONIC SAFE LOCKS</i>	44
MATERIALS HANDLING EQUIPMENT	45
MERCHANDISING / DISPLAYS	46
INDEX BY MODEL NUMBER	47



WALL SAFES

WALL SAFES

AMSEC **WALL SAFES** are designed to provide hidden protection for documents and miscellaneous valuables. Each wall safe is also designed for easy installation between 16" o/c wall studs. Pre-drilled anchor holes and a built-in flange eliminates unnecessary replastering.



WEST2114 FEATURES:

- Heavy duty steel body, 3/16" solid steel door and flange.
- Extra spacious interior, while still offering the convenience of fitting between studs.

WEST2114

- New State-of-the-art DL5000 electronic lock with a large 3 3/4" touch screen LCD input display allows smooth and easy operation.
- Mode altering display changes from orange in standby mode to bright blue in the open position.
- Accepts (2) user codes and can show open door records for the past 14 entries.
- LCD touch screen display shows low-battery indicator, time, date and keypad.
- Emergency key-lock override system with two (2) keys, power override battery box, built-in spy-proof function and motion detector alert.
- Dual live bolts ensure protection against pry attacks.
- Two removable shelves.
- Cream colored, durable powder coated finish.
- Packaged for UPS shipment.



WS1014

WS1014

FEATURES:

- U.L. listed Group II key changeable lock, with relock and 1 million possible combinations.
- Electronic lock optional, or Chicago single key camlock with 2 keys.
- Flat dial allows flush mounted installation.
- 3/16" thick solid steel door with dead bar.



WFS149E5LP

When fire is a concern, there is no better wall safe than the WFS149 or WFS149E5LP.

WFS149

FEATURES:

- UL Listed one hour fire rating, ensuring the inside temperature never exceeded 350° F (paper chars at 450° F).
- Extra deep interior, with one (1) convenient drawer shelf.
- Combo lock with key operated side-locking mechanism incorporating one chromed locking bolt.
- Each safe is equipped with side locking boltwork mechanism incorporating 1/2" steel deadbolts.
- Impressive 1/2" thick door with attractive two-tone Sage finish.



WS1214E5

HEAVY-DUTY WS1214E5

FEATURES:

- Same features as Super Brute Floor safes. Please see page 4.
- Two removable shelves. Extra deep interior.
- AMSEC's ESL5 electronic lock with illuminated keypad.

NEW! WFS149E5LP with New ESL5LP Electronic Lock:

- Illuminated Keypad
- Factory Reset Combination for resolving lost combinations without requiring expensive service calls.
- Beep and flash from every keystroke gives maximum feedback to the user.
- Lock can be programmed to silence the beep in stealth mode.
- 15-Minute Penalty Lockout after four incorrect entries protects against manipulation attempts.
- One 9-volt battery can be easily replaced in the keypad housing.

Model	Inside Dimension H x W x D	Outside Dimension H x W x D	Clear Door H x W x D	Cu. In.	Wt.
WS1014	10 x 13 3/4 x 3 1/2	12 1/4 x 15 3/4 x 4	9 5/8 x 12 3/4	481	20
WS1014K	10 x 13 3/4 x 3 1/2	12 1/4 x 15 3/4 x 4	9 5/8 x 12 3/4	481	22
WFS149*	14 x 8 1/2 x 10-5/8	19-1/8 x 13 1/2 x 15 3/4	14 x 8 1/2	1258	106
WFS149E5LP*	14 x 8 1/2 x 10-5/8	19-1/8 x 13 1/2 x 15 3/4	14 x 8 1/2	1258	106
WS1214E5	12 x 13 1/2 x 5 1/2	12 5/8 x 14 7/8 x 10	10 3/4 x 11 1/8	891	86
WEST2114	21-1/8 x 13-3/4 x 2-7/8	22-1/4 x 15 x 4	19-1/4 x 10-1/4	733	31

* 350° F, UL Listed, 1-Hr fire rated wall safe.



BRUTE, SUPER BRUTE AND MINI BRUTE SERIES

All BRUTE SERIES safes are designed to provide secure storage for documents, jewelry, precious metals and miscellaneous valuables at an economical price. When properly installed in a concrete floor, BRUTE SERIES safes provide excellent fire and burglary protection. BRUTE floor safes meet and exceed the requirements of the Insurance Offices Manual of Burglary Insurance. You may also add many options to customize your safe such as: A drop slot in the door, depository chute, digital keypad lock and keylocking dial to name a few. BRUTE SERIES safes may be installed in the floor, wall, cladding or within a larger safe.



**SUPER BRUTE
MODEL 2200E5
W/OPTIONAL COMBO LOCK SHOWN**



**TOP VIEW
OF B1500E5
SUPER BRUTE**

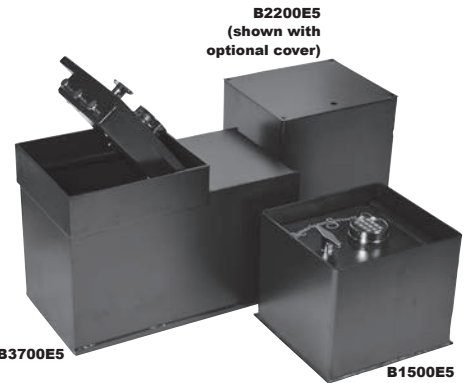

B3700E5

**B2200E5
(shown with
optional cover)**

B1500E5

**SUPER BRUTE & BRUTE
STANDARD FEATURES:**

- Black textured body and door.
- Attractive design offers strong reliable welds to protect against burglary attacks and reduce possible leakage.
- Every Brute Series safe now comes standard with AMSEC's ESL5 Electronic Lock with Illuminated Keypad in Bright Chrome. Optional combo lock available.
- An additional spring-loaded relocking device, activated by a punching attack.
- Lock and relocks are protected by a large carburized hardplate.
- A handle activated locking mechanism consisting of three 1" diameter locking bolts. Each one is drive resistant, chromed steel with a long throw.
- One piece heavy duty dead bar behind hinge prevents removal of door even if hinges are removed during a forced entry attempt.

- Door is designed to fit full body size, which greatly reduces any possible pry points.
- Doors are interchangeable within product group.

BODY:

- Oversize floor plate ensures strong installation in concrete.
- Flush cover plate.
- Solid steel hinge mechanism using 3/8" diameter steel hinge pins and internal mounting bolts.

**SUPER BRUTE SERIES
ADDITIONAL FEATURES:**

- The **SUPER BRUTE's** new door jamb design is manufactured with state-of-the-art equipment, with built-in devices offering the ultimate protection against sledgehammer attack.
- "B+" rate door: 3/4" **solid steel plate door** is standard.
- Doors are removable and interchangeable.
- A large, convenient 10 3/4" x 11 1/8" door opening for bulky items.
- One sliding shelf with double wide model (B3700). Two sliding shelves with triple wide models (B5800).
- Attractive carpeted floor in every unit.

For Slotted Door see Page 38

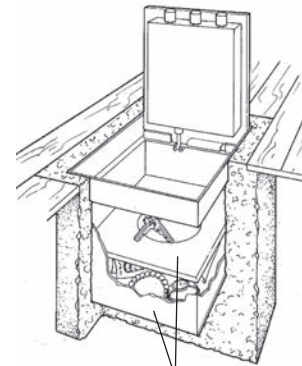

DOUBLE COMPARTMENT

**Super Brute Floor Safes
Lifetime Replacement Warranty:**

If your AMSEC Super Brute floor safe is subject of a sledgehammer or pry attack and is forcibly entered, AMSEC will replace or repair the safe (our option) with a current production model of comparable value - free of charge. The damaged safe must be returned freight prepaid to the factory within 30 days of the loss, accompanied by a properly filled police report. This warranty does not apply to damage or loss resulting from accident, alteration, unauthorized entry or improper installation. AMSEC's limited warranty policy and procedures applies to any extended product warranties.



BRUTE, SUPER BRUTE AND MINI BRUTE SERIES

SQUARE DOOR FLOOR SAFES



BRUTE RECTANGULAR BODY, WIDE DOOR

ADDITIONAL FEATURES:

- A large, convenient 11¾" x 16" door opening, for large bulky items or cash tray storage.
- B-rate door of ½" solid steel plate.

MINI BRUTE

DOOR:

- Black textured body and door.
- Large brass plated dial and black matte finish dial ring.
- ½" A36 solid steel plate. New steel guards protect lock and relock from accidental damage.
- U.L. listed Group II lock with relock. An additional relocking device, activated by punching attack.
- Heavy duty dead bar prevents removal of door during forced entry attempt.

- Convenient, reversible lift-out door with a heavy duty handle.
- Optional baffled drop slot in door

BODY:

- 8" square tubular "B" Rate construction.
- Universal jamb design allows the door to be positioned in all four directions.
- A flush cover plate for total concealment under a carpet.

SuperBrute "B" Rate Rectangular Hinged Door Floor Safes

Model	Inside Dimension H x W x D	Outside Dimension H x W x D	Clear Door H x W x D	Cu. In. Capacity	Wt.
B1500E5*	12¼ x 13¼ x 8¾	12¾ x 14½ x 11¼	10¾ x 11½	1377	102
B2200E5*	12¼ x 13¼ x 14	12¾ x 14½ x 17½	10¾ x 11½	2203	118
B2900E5*	12¼ x 13¼ x 18¼	12¾ x 14½ x 21½	10¾ x 11½	2872	134
B3800E5*	12¼ x 18 x 17	12¾ x 18¾ x 21½	10¾ x 11½	3864	136
B3700E5*	12¼ x 23 x 14	12¾ x 24 x 17½	10¾ x 11½	3785	145
B5800E5*	12¼ x 35 x 14	12¾ x 36 x 16¾	10¾ x 11½	5758	185

*Constructed of 3/4" door and B-Rate body. Slotted outer door not recommended for use on B1500.

Brute Wide Door "B" Rate Rectangular Hinged Door Floor Safes

Model	Inside Dimension H x W x D	Outside Dimension H x W x D	Clear Door H x W x D	Cu. In. Capacity	Wt.
B1806	12¼ x 18½ x 6	13¼ x 19½ x 9	11¾ x 16	1360	102
B1810	12½ x 18½ x 10	13¼ x 19½ x 13	11¾ x 16	2281	116
B1816	12¼ x 18½ x 16	13¼ x 19½ x 19	11¾ x 16	3626	142
B1816D*	12¼ x 18½ x 5¾ (top) 12¼ x 18½ x 10 (btm)	13¼ x 19½ x 19	11¾ x 16 (top) 6" DIA (btm)	1303 (top) 2266 (btm)	152

*Double Compartment - Slotted inner door. Slotted door not recommended for use on B1806.

"B" Rate Square Body / Lift-Out Door Floor Safes

Model	Inside Dimension H x W x D	Outside Dimension H x W x D	Clear Door H x W x D	Cu. In. Capacity	Wt.
B400*	7" x 7" x 6" x 6"	8½ x 8½ x 10" x 10"	6" x 6"	393	32

Slotted door not recommended for use on B400. *Optional UPS packaging available. See inside front cover for information.

STAR® ROUND LIFT-OUT DOOR



FLOOR SAFES are engineered with advanced security features. STAR Tube safes have been the standard for gas stations, fast food, small retail establishments and home owners for over 50 years.

Low cost, combined with the various body styles and optional doors will fit almost any cash handling system. When properly installed in concrete, STAR® FLOOR SAFES provide maximum fire and burglary protection. Now, with the water-resistant dust cover, you get protection from water as well.

“C” RATE LIFT-OUT DOOR FEATURES:

- Manipulation resistant, unitized U.L. Group II key changeable lock protected by a revolving carburized hardplate.
- Removable dial and drive/drill resistant spindle preventing damage from burglary attack and additional protection from hold-up.
- Door, 7-1/4" clear opening, is 1-3/4" solid steel.
- Door is securely locked by three bolts each requiring over 25,000 pounds to shear.
- Each locking bolt has its own hardened steel positive relocking bolt.
- Body — Heavy “B” rate construction.

OTHER FEATURES:

- Water resistant, high impact molded dust cover with rubber “O”-ring seal does not rattle or slide like most covers.
- STAR’s double compartment models provide the commercial user with the most effective cash handling system available. Hold-up as well as burglary protection is greatly enhanced by use of this type of safe.
- Available with dual key inner compartment. Manager holds one key, the armored car driver, or employee holds the second.



STAR® “C” RATE TUBULAR BODY SAFES



CUTAWAY VIEW OF STAR® DOUBLE COMPARTMENT

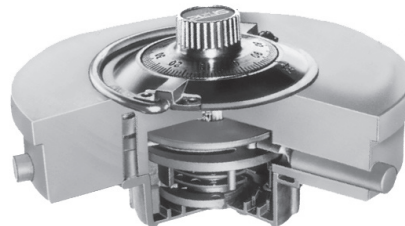

CUTAWAY VIEW “C” RATE LIFT-OUT DOOR



COMBINATION DOOR WITH DROP SLOT



WATER RESISTANT DUST COVER



KEYLOCK DOOR

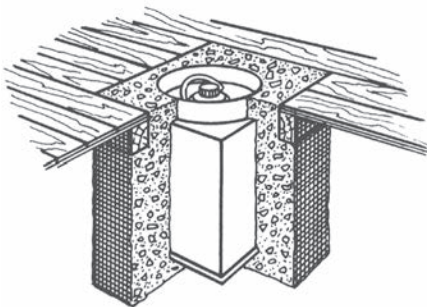

When properly installed in concrete, STAR® Floor Safes provide excellent fire and burglary protection. Now, with the water resistant dust cover, you get protection from water as well.

Model	Inside Dimension H x W x D	Outside Dimension H x W x D	Clear Door H x W x D	Cu. In. Capacity	Wt.
C3	8¼ DIA x 5¾	8¾ DIA x 9	7¼ DIA	280	40
C5	8¼ DIA x 10	8¾ DIA x 13½	7¼ DIA	510	48
C7	8¼ DIA x 16	8¾ DIA x 19	7¼ DIA	785	55
CD5*	8¼ DIA x 4¼ (top) 8¼ DIA x 4½ (btm)	8¾ DIA x 13½	7¼ DIA (top) 6¾ DIA (btm)	225 (top) 240 (btm)	54
CD7*	8¼ DIA x 5¼ (top) 8¼ DIA x 9 (btm)	8¾ DIA x 19	7¼ DIA (top) 6¾ DIA (btm)	175 (top) 480 (btm)	66

*Double Compartment - Slotted Inner Door



STAR® RECTANGULAR BODY, ROUND LIFT-OUT DOOR

FLOOR SAFES



Rectangular Body, Round Lift-out Door
"B" RATE

FLOOR SAFES offer a large cubic inch capacity at a reasonable price. Strong, continuously welded steel bodies are offered with our standard "C" rate lift-out combination door and water-resistant dust cover.

"C" RATE LIFT-OUT FEATURES

DOOR:

- Utilizes the STAR high security "C" Rate door.

BODY:

- "B" Rate construction available in double compartment models (D) or outside drop chute (BDP).



Model	Inside Dimension H x W x D	Outside Dimension H x W x D	Clear Door H x W x D	Cu. In. Capacity	Wt.
B6	12 x 10 x 5¼	12½ x 11¼ x 9¾	7¼ DIA	630	62
B17	12 x 12½ x 10	13 x 13 x 15	7¼ DIA	1500	98
B24	12 x 12½ x 14½	13 x 13 x 19	7¼ DIA	2175	122
BD24*	12 x 12½ x 5½ (top) 12 x 12½ x 10 (btm)	13 x 13 x 20	7¼ DIA (top) 6¾ DIA (btm)	825 (top) 1500 (btm)	130
BDP24*	12 x 12½ x 4¼ (top) 12 x 12½ x 13¾ (btm)	13 x 13 x 22	7¼ DIA (top) 6¾ DIA (btm)	638 (top) 2063 (btm)	142

*Double Compartment-Slotted Inner Door. **Double Compartment - Solid Inner Door with Outside Drop Chute



MAJOR® ROUND LIFT-OUT DOOR

MAJOR® Tubular Body, Round Lift-Out DOOR FLOOR SAFES provide excellent fire and burglary protection when properly installed in concrete.

"C" RATE LIFT-OUT DOOR FEATURES

- Unitized U.L. Group II key changeable lock with randomized opening positions defends against drill attacks.
- Drive resistant dial and spindle blocks sledgehammer attacks.
- Door, 6⁵/₈" clear opening, is 1" thick solid steel.
- Door is securely closed by three 5⁵/₈" drive resistant locking bolts.

- A positive relocking device jams locking mechanism in the event of a forced entry attempt.
- Recessed locking mechanism protected by a large carburized hardplate.
- Heavy duty "B" rate solid steel body with reinforced door jamb.
- Available in double compartment models (DD) with a key locking inner door.
- Inside slot to bottom compartment on all (DD) models.



Model	Inside Dimension H x W x D	Outside Dimension H x W x D	Clear Door H x W x D	Cu. In. Capacity	Wt.
T425	8¼ DIA x 5¾	8¾ DIA x 8¾	6¾ DIA	307	40
T625	8¼ DIA x 10¼	8¾ DIA x 13¼	6¾ DIA	545	46
T925	8¼ DIA x 15¾	8¾ DIA x 18¾	6¾ DIA	840	54
T625DD*	8¼ DIA x 4½ (top) 8¼ DIA x 5¼ (btm)	8¾ DIA x 13¾	6¾ DIA (top) 6¾ DIA (btm)	241 (top) 285 (btm)	54
T925DD*	8¼ DIA x 7½ (top) 8¼ DIA x 7¾ (btm)	8¾ DIA x 18¾	6¾ DIA (top) 6¾ DIA (btm)	401 (top) 420 (btm)	64

*Double Compartment - Solid Inner Door with Drop Chute.



CUTAWAY VIEW OF "MAJOR" DOOR



UNDERCOUNTER SAFES

AMSEC'S UNDERCOUNTER SAFES limit excess cash register funds by providing instant protection for interim deposits of cash or checks via the anti-fish deposit slot. Securely positioning the safe next to the cash register limits exposed cash and reduces the threat of robbery and internal theft. Adaptable for multi-unit installation use, ideal for gun control, staff use, athletics clubs, security areas and much more.



**(LOCK OPTION #1T)
TB0610-1T**

Chicago 7 pin camlock

FEATURES:

- Heavy gauge solid steel construction.
- Full width deposit slot over door equipped with an "anti-fish" saw tooth baffle to guard against pilferage or fishing.
- Heavy-duty piano hinges.
- Available with six different lock options to fit your specialized security requirements.
- Units can be bolted together utilizing bolt holes.
- Interchangeable doors allow flexible means of changing locking mechanisms without replacing the entire unit.
- Two anchor holes provided on all four sides.
- Attractive and durable powder coated black finish.

LOCK OPTIONS:

- Chicago single key camlock equipped with two keys. (Lock option -1)
- Chicago 7 pin radial key camlock, equipped with 2 keys. (Lock option 1T)
- Medeco® U.L. listed high security single key camlock supplied with two keys. Medeco's restricted keyways protect against unauthorized key duplication. (Lock option -2)
- Dual custody safe deposit key lock (two keys required to open safe). (Lock option -4)
- Best removable core key lock supplied without core. A removable core system lets you change the combination of any lock in seconds and can easily expand to include new facilities. Supplied without core. (Lock option -7, without core).
- Lock1One Group II key changeable combination lock offers 1 million possible combinations. (Lock option -6).
- Optional custom key control systems designed to your security requirements:
 - 1) Master Keyed
 - 2) Keyed Alike
 - 3) Keyed Different



**(LOCK OPTION -2)
TB0610-2**

Medeco® single key camlock



**(LOCK OPTION -1)
TB0610-1**

Chicago single key camlock



**(LOCK OPTION -7)
TB0610-7**

Best removable core key lock (core not included)



**(LOCK OPTION -4)
TB0610-4**

Dual custody safe deposit key lock



HEAVY DUTY SERIES

MODEL K1 AND K2

- 1/4" thick A36 solid steel plate hinged door.
- Full width slot over door.
- A saw tooth baffle guards against pilferage or fishing.
- Your choice of U.L. listed dual control keylock (K-2), a single key Medeco® lock (K-1), or a Chicago single key lock (K-1A).
- "B" Rate steel construction.
- May be installed vertically or horizontally.
- May be mounted on or under counter as space permits.
- Durable, impact resistant Charcoal Gray textured finish.

Model	Inside Dimension H x W x D	Outside Dimension H x W x D	Clear Door H x W x D	Cu. In.	Wt.
TB0610	5 7/8 x 5 7/8 x 8 3/4	6 x 6 x 10	5 7/8 x 5	289	6
K-1 / K-2	5 7/8 x 5 7/8 x 10	6 x 6 x 12	3-13/16 x 5	316	16

NOTE: Models TB0610 is available with the LaGard 33E electronic lock. (Factory installed primary lock.)

IMPORTANT:

AMSEC Undercounter safes are recommended for an operation that requires a non-returnable deposit. These safes are not meant for overnight storage of cash



RETAIL MONEY MANAGER SAFE

CASH MANAGEMENT SAFES

AMSEC's NEW RETAIL MONEYMANAGER SAFE offers unrivaled value in electronic safe access. Built tough to maximize protection against burglary attempts, the Retail MoneyManager has all the advanced features necessary for commercial applications.

Safe Features:

- Solid steel 1/2" thick door equipped with 10 solid steel Anti-Spread Pins
- Formed high tensile steel body and jamb construction to maximize protection against pry attack.
- Provided with 6 removable door mounted coin racks
- Reinforced internal jambs on all four sides provide protection against sledgehammer attack.
- 3-way locking system with five 1" dia. Chrome plated locking bolts.
- Bolt detent system engages boltwork and locks the door automatically.
- Auxiliary spring-loaded relocking devices.
- Locks and relocks protected by a large carburized hardplate.
- Standard Four (4) anchor bolt holes.

Interior Locker Features:

- Heavy 1/4" steel door, 9-1/4" H x 19-3/4" W x 13-1/2" (12-7/8" Clear) D
- Large clear door opening: 6-9/16" H x 14" W
- Locker door closes when outer door is closed.

Deposit Drawer Features:

- Large "fish" and "pry" resistant solid steel deposit drawer deposits.
- Drawer size: 2" x 4-1/4" x 9-1/2"



RMM2620SW-R

Lock Features:

- The Retail MoneyManager Safe is available with either the AMSEC SafeWizard® Electronic lock, AMSEC ES LAudit Electronic Lock or the AMSEC ESL20-XL Electronic Lock.

Model	Description	Inside Dimension H x W x D	Outside Dimension H x W x D	Clear Door H x W x D	Wt.
RMM2620SW-R	C-Store Cash Management Safe / Right Swing / with SafeWizard®	25¾" x 19¾" x 15-5/8"	26" x 20" x 18½"	18¼" x 15½"	280
RMM2620ESLAudit-R	C-Store Cash Management Safe / Right Swing / with ES LAudit	25¾" x 19¾" x 15-5/8"	26" x 20" x 18½"	18¼" x 15½"	280
RMM2620ESL15-R	C-Store Cash Management Safe / Right Swing / with ESL15 (Time Delay)	25¾" x 19¾" x 15-5/8"	26" x 20" x 18½"	18¼" x 15½"	280



RMM2620SW-R

More information on the SafeWizard® Lock can be found on Page 41



RMM2620ESLAUDIT-R

More information on the ES LAudit Lock can be found on Page 42



RMM2620ESL20-R

More information on the ESL20XL Lock can be found on Page 43



CASHWIZARD® BILL READER SAFES

American Security Products Co. (AMSEC) offers a new line of cash management smart safes for cash-intensive environments. **THE CASHWIZARD® BILL READER SAFES** Offers a wide range of capabilities from MEI bill validators increasing cash processing speeds, a thorough reporting system to make accurate and verified shift reports, a comprehensive access control system and remote capabilities to transmit data to the financial institution or armored car carrier for provisional credit.

All CashWizard Safes Feature:

Cash Management

- Deposit tracking system to provide the highest level of cash management security
- MEI Cashflow bill readers that count and verify cash deposits
- Manual Drop tracking for mutilated cash, coins, checks and other items
- Reports available by transaction, user, shift and business day
- Armored courier compatible

Access Control

- 10,000 audit entries and up to 40 users
- Time Delay any door
- Time Lock any door, 1-6 windows per day
- Authentication options: PIN code and/or Dallas Key
- Wrong PIN penalty lockout
- Duress Hold-Up Alarm with Silent Signal
- Burglary Alarm output signal
- Holiday schedule with up to 16 programmable events per year
- Automatic Daylight Savings Adjustment, selectable and configurable
- Dual control mode on any door
- Audit record written for each transaction

Remote Management

- Remote Management is available using CashWizard Admin and an Ethernet network connection
- Add/Edit/Delete Users
- Run Reports – Cash Management and Audit reports
- Manage System Settings – (Safe Time, Door Delay, End of Day, etc.)
- Create Event based Alerts for each safe (Cassette Full, Courier Event, Door Opened, etc.)

Options

- Single or Bunch Note Feeder bill readers.
- 1200 or 2200 Note Cassettes
- Door mounted printer or detached
- Lockable door for bill reader heads
- Manager Locker with second outer door

High Volume "All-In-One" 3-Door Dual Bill Reader - Specifications

- Equipped with the UL Listed AMSEC CashWizard Access Control System. Can be connected to Ethernet network for interface to back office PC or remote locations.
- Dual MEI Cashflow SCL-1200 note validators are standard. Can also be equipped with optional MEI Cashflow SCXL-2200 note validators.
- Integrated thermal direct printer provides system activity reports.
- Manual deposit drawer equipped with CashWizard access control lock. Authorized users can access deposit drawer, input currency and make an audited deposit. Anti-fish deposit drawer capacity: 7" L x 2½" W x 3¾" H.
- Inside deposit and storage area capacity: 6¾" H x 15½" W x 18½" D
- 3/8"-thick steel pry-resistant outer door equipped with a unique 3/8"-thick steel 3-point anti-spread deadlatch locking system, three dead bars and a bolt detent system to auto lock the safe when the door is closed.
- Provided with four 1/2" dia. anchor holes and mounting hardware.



BR3122x2
High Capacity Dual Bill
Reader Safe with
built-in printer

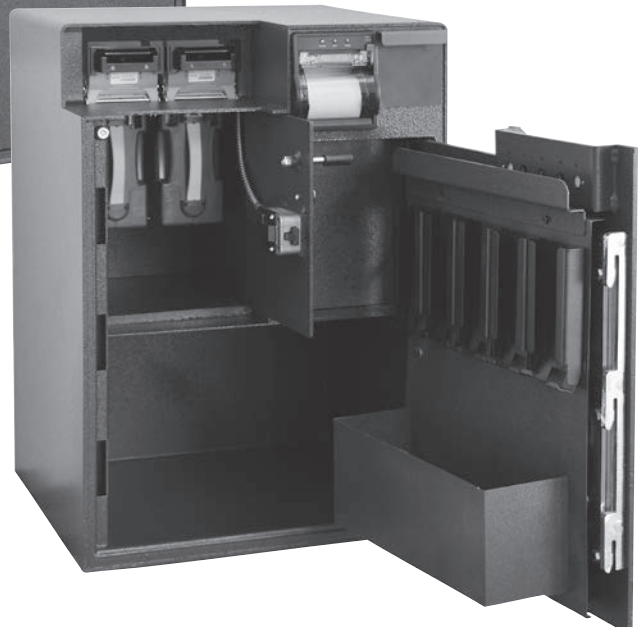



CASHWIZARD® BILL READER SAFES

CASH MANAGEMENT SAFES

CashWizard High Capacity Dual Bill Reader Specifications

- Equipped with the UL Listed AMSEC CashWizard access control system
- ½"-thick steel pry-resistant outer door equipped with anti-spread deadlatch locking system, dead bars and a bolt detent system to auto lock safe door
- Removable bill heads to easily clear jams
- Four ½" diameter anchor holes and mounting hardware
- Optional Manager Locker with second outer door: 9" H x 13" W x 18"D



BR3113x2
High Capacity Bill Reader Safe with built-in printer and showing optional Manager Locker



BR2213x2PP
High Capacity Bill Reader Safe

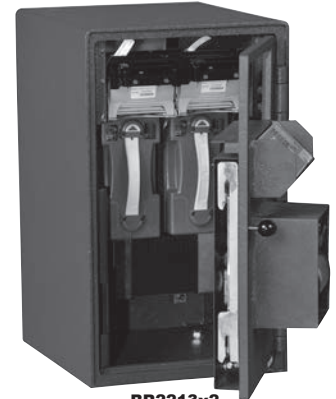

BR2213x2
High Capacity Bill Reader Safe with built-in printer

CashWizard Low Volume Single Bill Reader Specifications

- Equipped with the UL Listed AMSEC CashWizard access control system
- ½"-thick steel pry-resistant outer door equipped with anti-spread deadlatch locking system, dead bars and a bolt detent system to auto lock safe door
- Removable bill heads to easily clear jams
- Four ½" diameter anchor holes and mounting hardware
- Optional Manager Locker with second outer door: 9" H x 11½" W x 18" D



Optional Portable Printer



BR2212x1PP
Low Volume Bill Reader Safe



BR2212x1
Low Volume Bill Reader Safe with built-in printer



BR3112x1PP
Low Volume Bill Reader Safe with optional Manager Locker

Model	Description	Outside Dimension H x W x D	Wt.
CashWizard Safes with Built-in Printer			
BR3122x2	High Volume "All-In-One" 3 Door SmartSafe (Dual Bill Readers)	31 x 21.5 x 21	380
BR3113x2	High Volume "2 Door" SmartSafe (Dual Bill Readers)	31 x 13 x 22	256
BR2213x2	High Volume "1 Door" SmartSafe (Dual Bill Readers)	22 x 13 x 22	186
BR3112x1	Low Volume "2 Door" SmartSafe (Single Bill Reader)	31 x 11.625 x 22	234
BR2212x1	Low Volume "1 Door" SmartSafe (Single Bill Reader)	22 x 11.625 x 22	170
CashWizard Safes with Portable Printer			
BR3113x2PP	High Volume "2 Door" SmartSafe (Dual Bill Readers)	31 x 13 x 18	251
BR2213x2PP	High Volume "1 Door" SmartSafe (Dual Bill Readers)	22 x 13 x 18	181
BR3112x1PP	Low Volume "2 Door" SmartSafe (Single Bill Reader)	31 x 11.625 x 18	229
BR2212x1PP	Low Volume "1 Door" SmartSafe (Single Bill Reader)	22 x 11.625 x 18	165

Extra deep (XD) models also available. For more information, please see the AMSEC Price List, Page 16.



BWB SERIES - WIDE BODY CASH CONTROL

Extensive research and development went into the engineering of AMSEC'S **WIDE BODY "B" RATE CASH HANDLING DEPOSITORY SAFES**. Designed to offer complete cash management versatility with a front load depository option and a pull-out deposit drawer (Model BWB3020D1 only).



**BWB2020FL WITH
OPTIONAL SAFEWIZARD®**



BWB3020-D1



BWB2020-FL

BWB STANDARD FEATURES:

- Door: Massive 1/2" thick A36 solid steel plate.
- Formed high tensile steel body and jamb construction to maximize protection against pry attack.
- Reinforced internal jambs on all four sides to provide protection against sledgehammer attack.
- U.L. listed Group II, key changeable combination lock.
- Optional electronic locks available.
- 3-way locking mechanism consisting of five 1" diameter chromed steel locking bolts.
- Bolt detent system engages boltwork automatically.
- Locks and relocks protected by a large carburized hardplate.

- Auxiliary spring-loaded reloading devices.
- Convenient, door-mounted, recessed coin rack.
- Standard Four (4) anchor bolt holes.

INTERIOR LOCKER FEATURES:

- Heavy 1/4" steel door, and single-key camlock with two keys.
- Large clear door opening:
6" H x 12"W (for 20" W safes) or
6" H x 14"W (for 25" W safes).
- Inside Dimensions:
BWB2020 / BWB3020 / BWB4020:
8 5/8" x 19 3/4" x 14"
BWB2025 / BWB3025 / BWB4025:
8 5/8" x 24 3/4" x 19"
- Note: Front Load Depository - inside locker height restricted to 6".

DEPOSIT DRAWER FEATURES (ONLY MODEL BWB3020D1):

- Large "fish" resistant, pull out drop drawer deposits directly into standard interior locker.
Drawer size: 1 1/8" x 3 1/2" x 7 1/2"
- Heavy duty steel sliding drawer.

FRONT LOAD

DEPOSITORY FEATURES:

- Recessed heavy duty 1/8" construction with 1/8" door.
- Protected by dual "anti-fish baffles."
- Large package capacity: 4" x 9" x 11 1/2" (maximum).
- May be ordered in any one of four directions. Specify front, reversed, right load or left load.

EACH UNIT COMES EQUIPPED WITH AN INTERIOR LOCKER TO ACCOMMODATE DEPOSITS, A LARGE INTERIOR FOR STORAGE OF CASH TRAYS AND A DOOR-MOUNTED, RECESSED COIN RACK.

Model	Inside Dim H x W x D	Outside Dim † H x W x D	Clear Door H x W x D	Cu. In.	Wt*	Shelves
BWB2020FL	9 x 19 3/4 x 17	29 3/4 x 20 x 20	14 3/4 x 16 1/4	3,022	218	0
BWB2020FLNLS	19 3/4 x 19 3/4 x 17	29 3/4 x 20 x 20	14 3/4 x 16 1/4	6,630	260	0
BWB2020FLRNL	19 3/4 x 19 3/4 x 17	29 3/4 x 20 x 20	14 3/4 x 16 1/4	6,630	260	0
BWB2020FLR	9 x 19 3/4 x 17	29 3/4 x 20 x 20	14 3/4 x 16 1/4	3,022	218	0
BWB3020FL	19 x 19 3/4 x 17	39 3/4 x 20 x 20	24 3/4 x 21 1/4	6,380	278	2
BWB3020FLR	19 x 19 3/4 x 17	39 3/4 x 20 x 20	24 3/4 x 21 1/4	6,380	278	2
BWB4020FL	29 x 19 3/4 x 17	49 3/4 x 20 x 20	34 3/4 x 16 1/4	9,737	334	3
BWB4020FLR	29 x 19 3/4 x 17	49 3/4 x 20 x 20	34 3/4 x 16 1/4	9,737	334	3
BWB2025FL	9 x 24 3/4 x 22	29 3/4 x 25 x 25	14 3/4 x 21 1/4	4,900	285	1
BWB2025FLR	9 x 24 3/4 x 22	29 3/4 x 25 x 25	14 3/4 x 21 1/4	4,900	285	1
BWB3025FL	19 x 24 3/4 x 22	39 3/4 x 25 x 25	24 3/4 x 21 1/4	10,345	352	2
BWB3025FLR	19 x 24 3/4 x 22	39 3/4 x 25 x 25	24 3/4 x 21 1/4	10,345	352	2
BWB4025FL	29 x 24 3/4 x 22	49 3/4 x 25 x 25	34 3/4 x 21 1/4	15,790	440	3
BWB4025FLR	29 x 24 3/4 x 22	49 3/4 x 25 x 25	34 3/4 x 21 1/4	15,790	440	3
B-Rate Wide Body Depository Chest with Drawer						
BWB3020-D1	19 x 19 3/4 x 17	30 x 20 x 20	24 3/4 x 16 1/4	6,380	270	2

IMPORTANT:

AMSEC depository safes are recommended for an operation that requires a non-returnable deposit such as armored car companies, convenience stores, restaurants, etc. The top locker is not meant for overnight storage of cash or valuables.



DS SERIES - "B" RATE ROTARY AND FRONT LOADING

DEPOSITORY SAFES

AMSEC'S DS SERIES DEPOSITORY SAFES are designed to provide immediate deposits and storage for cash, jewelry and miscellaneous valuables.

Deposits can be made to a locked compartment via a top-loading rotary hopper, a reverse or a front-loading deposit door.



DSC2014KC



DSF2714K

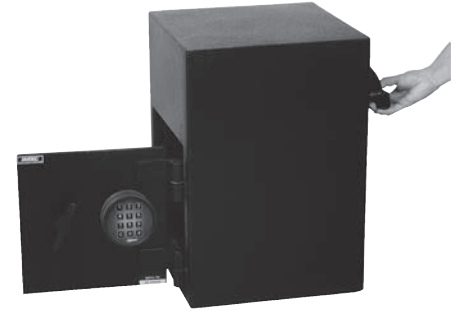

**REVERSE HOPPER
DSR2014 WITH ESL10XL**



DST2731KC



**DSF2014
WITH ESL10XL LOCK**

STANDARD FEATURES

BODY:

- Strong, formed "B" Rate construction made of A36 solid steel plate for improved security and appearance.
- Formed door jamb for increased resistance to sledgehammer attack.
- Four anchor bolt holes are standard.

**DOOR - MODEL NUMBERS:
2014, 2714 AND 3214**

- ½" thick A36 solid steel plate, recessed ½" to increase resistance to pry attack.
- U.L. Group II combo lock (C), U.L. listed dual nose keylock (K).
- Optional electronic locks available.
- Three 1" diameter chromed steel locking bolts.
- Bolt detent system engages boltwork automatically.
- Auxiliary spring-loaded reloading device.
- Lock and relock protected by large carburized hardplate.

**ADDITIONAL FEATURES:
WIDE BODY MODEL 2731**

- DOOR: (3) 1" x ½" rectangular plated bolts.
- Unique space-efficient, side-by-side design creates full depth depository and large storage compartment.
- Accepts cash trays up to 13" x 18".
- Optional coin rack available on storage compartment door.

HOPPER:

- 2014 is available w/reverse hopper.
- Large package sizes:
(Top Load Rotary):
4¾"D x 4¾"W x 10"L
(Front/Reverse Load):
4"D x 2¾"W x 10½"L
- Recessed, heavy duty 3/16" construction (¼" door).
- Protected by dual "anti-fish" baffles.

Model †	Inside Dimension H x W x D	Outside Dim* H x W x D	Clear Door H x W x D	Cu. In. Capacity	Wt.
DST2014	11½ x 13¾ x 11	20¼ x 14 x 14	9¾ x 9¾	1,739	87
DSF2014	10 x 13¾ x 11	20¼ x 14 x 14	9¾ x 9¾	1513	79
DSR2014	10 x 13¾ x 11	20¼ x 14 x 14	9¾ x 9¾	1513	94
DSC2014KC **	BOT 10¼ x 13¾ x 11 TOP 6¾ x 13¾ x 12¾	27¼ x 14 x 14	BOT 9¾ x 9¾ TOP 6 x 10¾	1513 1127	104
DST2714	18½ x 13¾ x 11	27¼ x 14 x 14	9¾ x 9¾	2798	101
DSF2714	17¼ x 13¾ x 11	27¼ x 14 x 14	9¾ x 9¾	2609	108
DST3214	TOP 12¼ x 13¾ x 11 BOT 11¼ x 13¾ x 11	32¼ x 14 x 14	9¾ x 9¾	1664 1890	152
DSF3214	TOP 11½ x 13¾ x 11 BOT 12½ x 13¾ x 11	32¼ x 14 x 14	9¾ x 9¾	1437/1815^ 1890/1702^	144
DST2731	LEFT 18½ x 14¾ x 18 RIGHT 27 x 16 x 18	27¼ x 30¾ x 21	LEFT 9 x 9¾ RIGHT 22½ x 14¾	4787 7776	285
DSF2731	LEFT 16¾ x 14¾ x 18 RIGHT 27 x 16 x 18	27¼ x 30¾ x 21	LEFT 9 x 9¾ RIGHT 22½ x 14¾	4399 7776	276

IMPORTANT:
AMSEC depository safes are recommended for an operation that requires a non-returnable deposit such as armored car companies, convenience stores, restaurants, etc. The top locker is not meant for overnight storage of cash or valuables.

†Specify Prefix: T=Top Loading, F=Front Loading, R=Reverse Hopper, K=Key Lock, C=Combo Lock, E=Electronic Lock

*Add 2" to outside depth for dial and handle projection.

**Camlock on locker, combination on deposit safe.

^Cubic inch capacity on DSF3214 change for CC and KK

MONEY MANAGER



AMSEC's "B" Rate Money Manager Series Undercounter Two Door Depository Safes are the most effective cash handling systems available. Engineered to help you achieve total cash control.

AMSEC's Money Manager Series is recommended for any operation that requires a non-returnable deposit such as armored car companies, convenience stores, restaurants, etc. The secured deposit and receiving compartments protect against mysterious disappearance and pilferage.

NEW! AMSEC's ESL15 electronic lock is now standard for this series!



**MM2820E15 TOP DROP
W/OPTIONAL KEY LOCK**



MM2820E15 CENTER DROP



MM2820E15 THREE DROP

STANDARD FEATURES:

- Heavy duty construction with 1/2" solid steel doors.
- Both doors equipped with AMSEC's ESL15 electronic lock. Optional key locks available, offering dual control.
- Optional combination locks available.
- Handle activated locking mechanism consisting of three 1" diameter locking bolts.
- Bolt detent device automatically engages bolts when doors are closed.
- Auxiliary spring-loaded reloading device, activated by a punch attack.
- Locks and relocks are protected by a large carburized hardplate.
- Formed door jamb and full length dead bar.
- Coin racks are standard on inside of storage door.
- Fish resistant depository drops accept bulk items, drop envelopes or bags.
- Cash drawers and bulky items conveniently fit into both compartments.
- Four anchor bolts and anchor hardware included.
- Available as a "top drop," "center drop," or "three drop" model.
- MM2820E15 front load and center drop hopper measures 16 1/4"W x 2"H x 3 1/2"D.
- Three individual color-coded 4" drops for shift control. Three deposit bins provided on "three drop" model.
- Attractive Black textured finish.

Model	Inside Dimension H x W x D	Outside Dimension H x W x D	Clear Door H x W x D	Cu. In. Capacity	Wt.
MM28203-Drop-E15	TOP 9 1/2 x 20 x 17 BTM 11 x 20 x 17	28 x 20 1/2 x 20	8 1/2 x 16 1/4 8 1/2 x 16 1/4	3,230 3,740	247
MM2820Top-Drop-E15	TOP 9 1/2 x 20 x 17 BTM 11 x 20 x 17	28 x 20 1/2 x 20	8 1/2 x 16 1/4 8 1/2 x 16 1/4	3,230 3,740	274
MM2820Ctr-Drop-E15	TOP 10 3/8 x 20 x 17 BTM 10 3/8 x 20 x 17	28 x 20 1/2 x 20	8 1/2 x 16 1/4 8 1/2 x 16 1/4	3,230 3,740	278



BWB SERIES AND MS1414

"B" RATE SECURITY SAFES

The many different features of the WIDE BODY SAFES, make them perfect for commercial application or home use.



BWB3020



BWB2020



**MS1414 WITH
ESL10XL LOCK**



**MS1414KS WITH
SLOT OPTION**

**Standard Features for
BWB:**

- ½" thick solid steel door, recessed for resistance to pry attacks.
- Formed, high-tensile steel body and jamb construction to maximize protection against pry attacks.
- U.L. listed Group II key changeable combination lock with over 1 million possible combinations.
- Optional electronic locks available.
- Auxiliary spring-loaded relock device.
- Locks and relocks protected by a large carburized hardplate.
- Attractive Black textured finish.
- BWB: Four anchor bolt holes with hardware.

Additional BWB Series Features:

- Reinforced internal jambs on all four sides to provide excellent protection against sledgehammer attack.
- 3-way locking mechanism consisting of five massive 1" diameter chromed steel locking bolts.
- Bolt detent system keeps bolts retracted when the door is open, then automatically engages when door is shut.
- Convenient door mounted recessed coin rack.
- Large capacity for storage of cash trays.
- Adjustable shelves.

Mini Safe (MS Series) Features:

- Strong, formed "B" Rate construction made of A36 solid steel plate for improved security and appearance.
- Formed door jamb for increased resistance to sledgehammer attack.
- ½" solid steel door.
- U.L. Group II combo lock (C), U.L. listed dual nose keylock (K).
- Three 1" diameter chromed steel locking bolts.
- Bolt detent system engages boltwork automatically.
- Auxiliary spring-loaded relocking device.
- Lock and relock protected by large carburized hardplate.
- Four anchor bolt holes with hardware.
- Adjustable shelf provided.
- Also available with optional deposit slot (s). (shown above) Slot size: ½" H x 6 W"

Model	Inside Dim H x W x D	Outside Dim* H x W x D	Clear Door H x W x D	Cu. In. Capacity	Wt	Shelves
BWB2020	19¾ x 19¾ x 17	20 x 20 x 20	14¾ x 16¼	6,631	154	1
BWB3020	29¾ x 19¾ x 17	30 x 20 x 20	24¾ x 16¼	9,988	218	2
BWB4020	39¾ x 19¾ x 17	40 x 20 x 20	34¾ x 16¼	13,346	272	3
BWB2025	19¾ x 24¾ x 22	20 x 25 x 25	14¾ x 21¼	10,754	235	1
BWB3025	29¾ x 24¾ x 22	30 x 25 x 25	24¾ x 21¼	16,198	306	2
BWB4025	39¾ x 24¾ x 22	40 x 25 x 25	34¾ x 21¼	21,644	440	3
MS1414	13¾ x 13¾ x 11	14 x 14 x 14	9¾ x 9¾	2080	67	1

*Add 2" to outside depth for handle, dial and hinge projection.

IMPORTED U.L. LISTED SAFES



The economical range of our **IMPORTED RESIDENTIAL FIRE SAFES (ELECTRONIC and COMBO)** is the answer's to today's high incidence of residential fires. Our Fire Safes also provide burglary protection making them ideal for home and light commercial applications. Our FS2215 **IMPORTED COMMERCIAL FIRE SAFE** is larger and perfect for both commercial and residential applications.



AMSEC's FS Series is the only 1hr. economical fire safe with a high-security electronic lock.

Other Brands **AMSEC**



FS149



FS2215

IMPORTED RESIDENTIAL FIRE SAFES (ELECTRONIC)

FEATURES:
FS712E5LP, FS914E5LP / FS149E5LP / FS1814E5:

U.L. Listed, 350°F, 1-Hr fire protection.

Units with NEW ESL5LP Electronic lock feature:

- Illuminated Keypad
- Factory Reset Combination for resolving lost combinations without requiring expensive service calls.
- Beep and flash from every keystroke gives maximum feedback to the user.
- Lock can be programmed to silence the beep in stealth mode.
- 15-Minute Penalty Lockout after four incorrect entries protects against manipulation attempts.
- One 9-volt battery can be easily replaced in the keypad housing.

Models FS914E5LP and FS149E5LP come with slide-out drawer, anchor holes and anchor hardware. Models FS1814E5 and FS2215 come with a key-locking drawer, adjustable shelf, anchor holes and anchor hardware.

Mechanical combination units (FS) come with standard mechanical combination lock plus key lock.

IMPORTED RESIDENTIAL FIRE SAFES (COMBO)

FEATURES:

FS914 / FS149:

- U.L. Listed 350°F 1-Hour fire rating.
- Models FS914 and FS149 have one (1) internal anchor hole and hardware, four (4) rubber feet and one (1) drawer shelf (except model FS712 that has a removable shelf).
- Key operated side-locking mechanism incorporating two chromed locking bolts.
- Two deadbolts prevent door removal if hinges are removed during a forced entry attempt.
- Attractive two-toned sage finish.

FS2215 IMPORTED COMMERCIAL FIRE SAFE

FEATURES:

- U.L. Listed 350°F 1-Hour fire rating.
- Model FS2215 offers a Group 2 combination lock with a Spyproof dial and ring, one (1) key-lock drawer, one (1) adjustable shelf, four (4) rolling casters for ease of movement and additional chrome "L" handle.
- Automatic relocking device triggered by force entry attempt.
- Handle operated side, top and bottom locking mechanism incorporating four steel chromed locking bolts.
- Two steel deadbolts prevent door removal if hinges are removed during a forced entry attempt.
- Ball bearing hinges for ease of operation.
- Attractive two-toned sage finish.



OPTIONAL LED LIGHT KIT WITH MOTION SENSOR AVAILABLE FOR ALL MODELS. SEE PAGE 26 FOR DETAILS.

Residential Fire Safes (Electronic and Combo)

Model	Inside Dim H x W x D	Outside Dim* H x W x D	Clear Door	Cu. In.	Wt
FS712E5LP	7 x 11¼ x 8-3/8	11¼ x 16½ x 13¾	7 x 11¼	660	70
FS914E5LP	8-7/16 x 14 x 10½	13½ x 19-1/8 x 15¾	8-7/16 x 14	1,107	96
FS149E5LP	14-1/8 x 8¼ x 10¾	19-1/8 x 13½ x 15-11/16	14-1/8 x 8¼	1,258	96
FS1814E5	18¼ x 13-1/8 x 12-3/8	23-5/8 x 18-7/8 x 18-7/8	18¼ x 13-1/8	2,920	187
FS914	8-3/8 x 14 x 10¾	13½ x 19-1/8 x 15¾	8-3/8 x 14¼	1,189	96
FS149	14-1/8 x 8¼ x 10¾	19-1/8 x 13½ x 15-11/16	14-1/8 x 8¼	1,258	96

*Add 2" for handle, dial and hinge projection.

Model FS2215 has one key-lock drawer and one adjustable shelf.

Outside height includes casters on model FS2215.

Above dimensions have been converted from metric measurements. Please allow +¼" to ½" variation for both outer and inner dimensions listed.

Residential Fire Safes (Electronic and Combo)

Model	Inside Dim H x W x D	Outside Dim* H x W x D	Clear Door	Cu. In.	Wt
FS2215	17¼ x 13-7/8 x 13-3/8	30-3/8 x 19¾ x 19-3/8	17¼ x 13-7/8	2,786	225



U.L. LISTED 2-HOUR FIRE AND IMPACT SAFES

UL SERIES



UL1812GR

FEATURES:

- The best warranty in the business. Lifetime fire replacement and one year parts and labor.
- U.L. listed Class 350°F two hour fire and impact rating.
- Safes withstand fires of up to 1850°F for two hours and a 30' drop – equivalent to falling through a 2 story burning building.
- Increased barriers for burglary protection. Impressive 3½" thick recessed door with 5/8" thick front for excellent pry resistance.
- Handle activated locking mechanism with 7/8" diameter solid steel chrome plated locking bolts offering smooth operation.
- Internal anchor bolt hole with hardware.
- U.L. listed Group II key changeable combination lock with relock. 1 million possible combinations.
- Auxiliary spring-loaded relock device activated by severe attack.
- Heavy duty steel hinges provide additional security and smooth operation.
- For your convenience, rubber feet are standard on models UL1511 – 1812X.
- Heavy duty rolling casters on UL2018 and up.
- Attractively accented with a brass or chrome handle, decorative emblems and plush velour interior.
- Available in durable Sandstone or Granite textured finishes.



OPTIONAL LED LIGHT KIT WITH MOTION SENSOR AVAILABLE FOR ALL MODELS. SEE PAGE 26 FOR DETAILS.

U.L. Safes Lifetime Replacement Warranty:

All AMSEC U.L. Listed fire safes are protected by a LIFETIME FREE REPLACEMENT GUARANTEE, assuring the original owner free replacement of safes that are damaged beyond repair by a fire with a current production model of comparable value. The damaged safe must be returned freight prepaid to the factory within 30 days of the loss, accompanied by a properly filed fire department report.

Model	Inside Dim H x W x D	Outside Dim* H x W x D	Cu. In. Capacity	Wt	Shelves
UL1511	15½ x 11½ x 12	21¼ x 17 x 18½	2,139	246	1 Adj. Shelf 1 Base
UL1812	18½ x 12½ x 12	25 x 18 x 18½	2,775	272	1 Adj. Shelf 1 Base
UL1812X	18½ x 12½ x 17	25 x 18 x 23½	3,931	298	1 Adj. Shelf 1 Base
UL2018	20 x 18 x 18	30¼ x 25½ x 25½	6,480	542	2 Adj. Shelf 1 Base
UL3918	39 x 18 x 18	49¼ x 25½ x 25½	12,636	808	2 Adj. Shelf 1 Base

* ADD 2" FOR HANDLE, DIAL AND HINGE PROJECTION. OUTSIDE HEIGHT INCLUDES 1" HIGH RUBBER FEET ON MODELS UL1511-UL1812XD; 2¼" FOR CASTERS ON THE THREE LARGEST MODELS. Hardware on above safes specify (*): Brass (LTG) on Sandstone and Chrome (LTE) on Granite Color Options Specify (**): (GR) = Granite, (ST) = Sandstone

U.L. FIRE RESISTIVE RATING CLASSIFICATION

THE FOLLOWING IS AN EXPLANATION OF THE UNDERWRITER'S LABORATORIES' FIRE RESISTANT CONTAINER TESTING PROCEDURES ON THE CLASS 350°F, ONE HOUR AND TWO HOUR FIRE LABELS.

U.L. Label/Class 350°F-one hour and Class 350°F-two hour. The safe will maintain an interior temperature less than 350°F when exposed to fire for a period of one hour at 1700°F or for a period of two hours at 1850°F. Safe must successfully undergo all other requirements for the Fire Endurance Test, Explosion Hazard Test and the Fire/Impact Test as stated below.

FIRE ENDURANCE TEST

After heat sensors and paper are placed inside the safe, the unit is locked and exposed to a uniformly distributed fire. The furnace is regulated to reach a maximum temperature of 1700°F for a period of one hour, or 1850°F for two hours, then allowed to cool without opening the furnace. The interior temperature is recorded throughout the test and during the cooling period until a definite drop is shown and must never exceed 350°F.

Once cooled, the unit is opened and examined for usability. The units locking mechanisms and parts fastenings are examined for security and the interior examined for visible evidence of undue heat transmission.

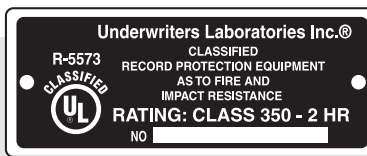

EXPLOSION HAZARD TEST

The safe is locked and placed into a furnace preheated to 2000°F. This temperature is maintained for 30 minutes (2 hour test is 45 minutes) and if no explosion results, the unit is allowed to cool without opening the furnace doors. Once cooled, the unit is opened and examined for usability. The units locking mechanisms and parts fastenings are examined for security and the interior examined for visible evidence of undue heat transmission.

FIRE IMPACT TEST (MANUFACTURER'S OPTION)

After the explosion hazard test the safe is removed from the furnace and within two minutes is dropped 30' onto a riprap of brick on a heavy concrete base. After impact the unit is examined for deformation, rupture of parts, damaged insulation and any other openings into the interior of the unit. Once cooled, the unit is inverted and reheated to 1550°F for a period of 30 min. (2 hour test: 45 min. at 1638°F).

Once cooled, the unit is opened and examined for usability. The units locking mechanisms and parts fastenings are examined for security and the interior examined for visible evidence of undue heat transmission.

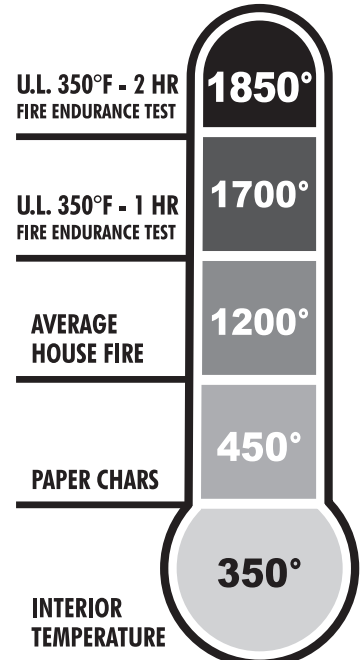

U.L. LISTED FIRE RATED BURGLARY SAFES



The AMSEC **BF® SERIES** offers a unique design that combines all the security features of a burglary safe and the peace of mind achieved with a fire safe. The industry's first U.L. Listed, fire-rated burglary safe offers an affordable solution when burglary and fire protection are an essential part of your buying decision!

During Underwriter's Laboratories grueling testing procedures, the **BF® SERIES** earned the U.L. Listed Class 350°F One Hour Fire Label and the (RSC) Residential Security Container Burglary Label.



BF3416ST
SHOWN WITH
OPTIONAL STORAGE
CABINETS (PG 27)



BF2116



BF1512

FEATURES

- The best warranty in the business. Lifetime fire replacement and one year parts and labor.
- "B" rated heavy duty construction.
- 1-Hr. 350°F factory fire rating. Tested at temperatures up to 1700°F.
- U.L. listed Group II lock with spring-loaded auxiliary relock device.
- ¼" heavy duty carburized hardplate.
- Heavy duty steel hinges provide easy smooth door operation.
- One recessed anchor bolt hole and mounting hardware are provided to securely anchor safe.
- Attractively accented with a large chrome-plated dial, matching handle and a plush velour interior.
- Durable and attractive granite finish or sandstone textured with a plush velour interior. Optional high-gloss finishes available.
- Optional electronic locks are available. **SEE PAGES 42-44.**
- Optional storage cabinets available on models BF3416 and BF1716. **SEE PAGE 27.**

Door:

- 3½" thick, consisting of ½" plate steel with a unique proprietary fire and burglary resistant material.
- Dual seal design utilizes a silicone foam seal with a heat-expanding intumescent seal.*

Body:

- 2⅝" thick, consisting of ⅛" outer and inner steel plates creating a burglary resistant structure enclosing a unique proprietary fire resistant material.
- Three massive 1" diameter solid steel chrome-plated locking bolts.
- A full length dead bar locks deep into the body preventing door removal during a forced entry attempt.



OPTIONAL LED LIGHT KIT WITH MOTION SENSOR AVAILABLE FOR ALL MODELS. SEE PAGE 26 FOR DETAILS.

BF® Safes Lifetime Replacement Warranty:

If your BF® safe is exposed to fire and failed to protect the contents, your BF® safe will be replaced free of charge. Just return the safe freight prepaid to the factory accompanied with the fire report. Contact your dealer for further details.



*INTUMESCENT DOOR SEAL:

When the intumescent seal is exposed to high temperature (above 250°F), it expands to as

much as 8 times it's original thickness. In this expanded or reactive state, it has very high thermal insulating capacity and resistance to breakdown. This provides a strong positive seal between the door and body, preventing heat influx.

Model	Inside Dim H x W x D	Outside Dim [^] H x W x D	Clear Door H x W x D	Cu. In.	Wt	Shelves
BF1512 (*)(**)	15 x 12 x 13	20¼ x 17¼ x 18¾	15 x 12	2,340	288	1
BF1716 (*)(**)	17 x 16½ x 16	22¼ x 21¾ x 21¾	17 x 16½	4,488	412	1
BF2116 (*)(**)	21 x 16½ x 14½	26¼ x 21¾ x 20¼	21 x 16½	5,024	476	1
BF3416 (*)(**) †	34 x 16½ x 16	39¼ x 21¾ x 21¾	34 x 16½	8,976	690	2

BOLT DOWN KIT INCLUDED, [^]ADD 2" FOR DIAL & HANDLE
Hardware on above safes specify (*): Brass (LTG) on Sandstone and Chrome (LTE) on Granite
Color Options Specify (**): (GR) = Granite, (ST) = Sandstone
† 1/2 hour U.L. Fire Rating



CSC SERIES COMPOSITE SAFES

COMMERCIAL SECURITY SAFES

AMSEC **CSC SERIES COMPOSITE SAFES** are an affordable solution when you want to protect both documents from fire and valuables from burglary attacks. During extreme testing procedures the **CSC SERIES COMPOSITE** safes passed a 2-Hour, 350°F factory fire test certification.



Interior temperature less than 350°F for a period of 2 hours at 1850°F



CSC4520



**CSC3018 WITH
OPTIONAL STOR-IT CABINET**



CSC1913

Features:

Door:

- Overall thickness of 4-5/8" and is constructed with a 2" defense barrier of outer and inner steel plates creating a burglary resistant structure enclosing a unique proprietary, fire resistant material.

Body:

- Total protective thickness of 2-7/8" enclosing a unique, high-density fire and burglary resistant composite material.
- Durable powder coated adjustable shelves.
- Removable casters provide easy delivery and installation.

Fire Endurance:

- 2 hour, 350°F factory fire rating. Tested at temperatures up to 1700°F.
- Heat expandable intumescent door seal guards contents against severe fires.

Locking Mechanism:

- Two to four 1½" diameter solid steel chrome-plated locking bolts.
- Two to three 1½" diameter solid steel dead bolts lock deep into body preventing door removal during a forced entry attempt.
- U.L. Listed Group II combination lock with chrome-plated spy-proof dial. Optional electronic locks available.
- Lock protected by a tempered glass relock device.
- Heavy duty steel hinges provide easy, smooth door operation.
- One internal counter-sunk anchor hole and mounting hardware are provided to securely anchor safe.
- Attractively accented with a full width fascia panel and matching three point handle,
- Durable and attractive charcoal gray textured finish.



CSC1413

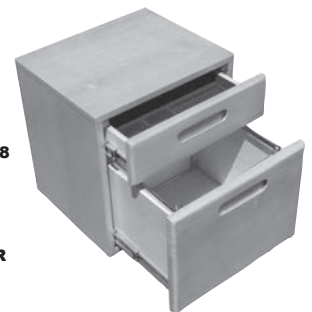

OPTIONAL STORAGE CABINETS AVAILABLE IN MODELS CSC3018 AND CSC4520. NO KIT NEEDED, DRAWERS SLIDE RIGHT IN. SEE PAGE 27 FOR MORE DETAILS

Model	Inside Dim H x W x D	Outside Dim* H x W x D	Cu. In.	Wt	Shelves	Rubber Feet or Casters
CSC1413	14 x 12.5 x 12.2	19.5 x 18 x 19.9	2,135	256	1	Rubber Feet
CSC1913	19 x 12.5 x 12.2	24.5 x 18 x 19.9	2,898	318	2	Rubber Feet
CSC3018	30 x 18 x 16.3	35.5 x 23.5 x 24	8,802	530	3	Casters
CSC4520	45 x 20 x 21.2	50.5 x 25.5 x 28.9	19,080	944	4	Casters

* Add 2" to outside depth for handle, dial and hinge projection.

* Add 4¼" (casters) and 1" (rubber feet) to outside height.



OPTIONAL LED LIGHT KIT WITH MOTION SENSOR AVAILABLE FOR ALL MODELS. SEE PAGE 26 FOR DETAILS.

NEW! HS SERIES - HIGH SECURITY RFX & RF MODELS



RF6528



The RF6528 Features:

The only U.L. Listed TL-30 burglary and fire resistant gun safe on the market.

Overall thickness of door is 6" and is constructed with a 3" defense barrier of outer and inner steel plates creating a single structure enclosing a unique, high density fire and burglary resistant composite material.

The RF6528 formed body has a total protective thickness of 3½" enclosing a high density fire resistant composite material with nuggets and steel fibers.

2 Stage Dual fire seals with silicone seal on door jamb and expandable Palusol™ seal on door.

A reinforced drill resistant door frame protects the door and each individual bolt chamber from severe side attacks.

Group 2M Lock is protected by a proprietary patented hard plate, dual external relocker and one internal relocker.

A proprietary inner barrier protects against peeling attacks.

RFX Series Safes Feature:

The new RFX Series U.L. Listed TL-30x6, six-sided high-security gun safes are made in the United States using the latest testing procedures set forth by Underwriters Laboratories.

The new revolutionary RFX Series is constructed with a 3" defense barrier of inner and outer steel plates enclosing a unique interlocking heavy duty steel barrier, 12,000 PSI high-strength concrete and a high-density high-strength ceramic matrix.

The high density insulating materials incorporated in the door and body also insure two hours of certified fire protection. The superior design and craftsmanship make the new RFX Series impervious to burglary attacks attempted by the most sophisticated equipment utilized today and the vaults contents against intense fires.

RFX703620 & RFX582820



INTERIOR FOR RF6528:

"ALL-IN-ONE" 12-18-30 GUN

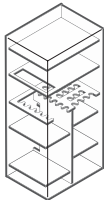

INTERIORS FOR RFX SERIES:

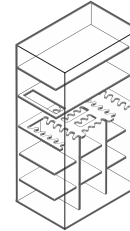

RFX703620 12-14-24-26-38 GUN

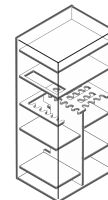

RFX582820 12-18-30 GUN

COLOR OPTIONS FOR HS SERIES SAFES:

High-Gloss Exterior Colors:

Hunter Green Metallic (HG), Onyx (OX), Burgundy Metallic (BY), Pearl (PW), Platinum Metallic (PL), Charcoal Metallic (CM), Macadamia Metallic (MM)

Textured Exterior Colors:

Granite (GR), Sandstone (ST), Black (BK), Chocolate Brown (CB)



Model	Outside Dimension H x W x D	Thickness (Inches)		Interior Capacity	Wt. Lbs.
		Door	Body		
RFX703620	76" x 42" x 29¼"	6"	3½"	12-14-24-26-38 Gun	4,578
RFX582820	64" x 34" x 29¼"	6"	3"	12-18-30 Gun	3,418
RF6528	72" x 35" x 29.5"	6"	3"	12-18-30 Gun	3,455

GUN SAFE FIRE AND BURGLARY PROTECTION

American Security Products Co. is highly acclaimed for offering the industry's best fire protection. We manufacture the industry's broadest gamut of fire-rated products ranging from Underwriters Laboratories (U.L.) Listed 1 and 2 hour fire safes to our independent laboratory tested 2 hr., 1 hr., 45 minute and 30 minute fire protected gun safes.

*Each safe is designed to maintain an interior temperature less than 350°F.

Paper products will char at approximately 450°F.

Series	Fire Label	Outside Temp	Time Period	Inside Temp Less Than
RFX Series	120 Minute	1850°F	120 min.	350°F
RF6528	120 Minute	1850°F	120 min.	350°F
BF® Series	ETL 120 Minute	1200°F	120 min.	350°F
SF Series	60 Minute	1200°F	60 min.	350°F
FV Series	45 Minute	1200°F	45 min.	350°F
TF Series	30 Minute	1200°F	30 min.	350°F



THE BF® SERIES GUN SAFES

GUN SAFES

THE MOST UNIQUE GUN SAFE IN THE INDUSTRY



NEW BF6024 Gun Safe

BF®
Burglary/Fire



THE BF® SERIES FEATURES:

- ½" steel plate door combined with 1" DryLight insulation. (BF7250 & BF6024 have 3/8" steel plate.)
- 2" total wall thickness on all sides featuring our poured DryLight insulation and two layers of steel for exceptional fire and security protection. Total combined steel thickness of walls is 7ga.
- U.L. Residential Security Container (RSC) Burglary Classification.
- 11 massive 1½" chrome-plated bolts. Bolt detent system holds bolts in open position.
- ETL Verified Fire protection of 1200°F for 120 minutes. Designed to maintain an interior temperature of less than 350°F.
- Adjustable ball bearing hinges.
- Available with Left Swing or Right Swing door

- 2 Stage Dual fire seals with silicone seal on door jamb and expandable Paluso!™ seal on door.
- U.L. Listed Group II Lock with massive hard plate and two relocking devices.
- Spy-proof, key-locking dial with decorative five-spoke handle and a convenient pull handle.
- BF6024 offers a chrome or brass "L" handle and does not come with a pull handle.
- Bold zinc die-cast polished logos and hardware in brass, chrome or black nickel. (Black nickel not available on BF6024).
- Optional electronic locks are available.
- Unique mirrored back wall for added interior visibility.
- Premium Door Organizer (PDO). See Page 27 for more details.
- Standard built in internal AC power port with removable external power cord.
- 4 pre-cut anchor holes.
- Interior features rich pin-dot fabric and adjustable interior shelving.



Shown with Optional Stor-it Cabinets and LED Light Kit

All BF® Series Safes Feature DryLight Insulation

American Security Product's **DryLight** is an advanced poured concrete insulation material that eliminates the use of gypsum board and provides a dry and seamless barrier to protect valuables against intense fires and burglary attacks.

LOCKING BOLTS

11 1/2"

WALLS

2"

1/2" PLATE DOOR

4 3/4"

Poured Drylight Fill BF7250 & BF6024 have 3/8" Plate

Model	Outside Dimension H x W x D	Thickness (Inches)		Interior Capacity	Wt. Lbs.
		Door Overall / Steel plate	Body		
BF7250	71.25" x 50" x 28"	4 ⁵ / ₈ / 3/8"	2	12-23-24-35-47 + 2 Gun 73 + 2 Gun	1,789
BF7240	71.25" x 40" x 26"	4 ³ / ₄ / 1/2"	2	12-14-24-26-38 + 2 Gun 58 + 2 Gun	1,585
BF6636	65.25" x 36" x 26"	4 ³ / ₄ / 1/2"	2	12-19-31 + 2 Gun	1,319
BF6030	59.25" x 30" x 26"	4 ³ / ₄ / 1/2"	2	11-14-25 + 2 Gun	1036
BF6032	59.25" x 30" x 21"	4 ³ / ₄ / 1/2"	2	7-11-18 + 2 Gun	913
BF6024	59.25" x 24" x 21"	4 ³ / ₄ / 1/2"	2	8-8-16 Gun + 1 Gun	720

Dimensions listed are exterior dimensions. Add 2-3/8" on all BF safes to overall depth for lock and handle.

COLOR OPTIONS:

High-Gloss Exterior Colors:

Hunter Green Metallic (HG), Onyx (OX), Burgundy Metallic (BY), Pearl (PW), Platinum Metallic (PL), Charcoal Metallic (CM), Macadamia Metallic (MM)

Textured Exterior Colors:

Granite (GR), Sandstone (ST), Black (BK), Chocolate Brown (CB)

Two-Tone Finishes:

Onyx High-gloss door / Black Textured body or Charcoal Metallic High-gloss door / Granite Textured body

Any combination available on request

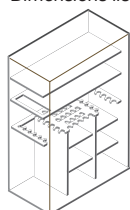

12-23-24-35-47 GUN INTERIOR
for Model BF7250

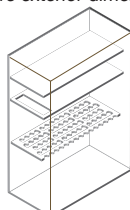

73 GUN INTERIOR
for Models: BF7250

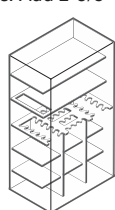

12-14-24-26-38 GUN INTERIOR
for Model BF7240

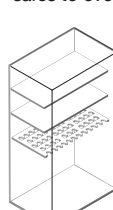

58 GUN INTERIOR
for Models: BF7240

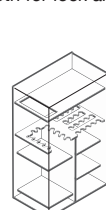

12-19-31 GUN INTERIOR
for Models: BF6636

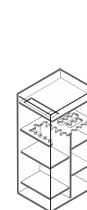

11-14-25 GUN INTERIOR
for Models: BF6030

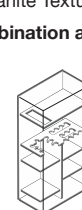

7-11-18 GUN INTERIOR
for Model BF6032

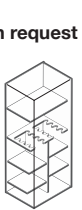

8-8-16 GUN INTERIOR
for Model BF6024

SF SERIES - SIXTY MINUTE FIRE



SF6030

All SF Series Safes Feature:

- 1/4" Steel Plate door with 3 layers of fire insulating material.
- Fire protection of 1200°F for 60 minutes. Designed to maintain an interior temperature of less than 350°F.
- U.L. Residential Security Container (RSC) Burglary Classification.
- 2 Stage Dual fire seals with silicone seal on door jamb and expandable Palusol™ seal on door.
- Body constructed of 12-gauge solid steel plate with a fire insulating material.
- U.L. Listed Group II Lock with massive hard plate and two relocking devices.
- Optional electronic lock available.
- New ultra smooth cam driven locking mechanism with increased handle rotation.
- 3-point handle in brass, chrome or black nickel and bold zinc die-cast polished logos in brass, chrome or black nickel.
- 4-way boltwork with 9 active 1 1/2" chrome-plated bolts and 5 deadbolts for a total of 14 bolts.
- All-velour interior.
- Premium Door Organizer (PDO). See Page 27 for more details.
- Four (4) pre-cut anchor holes with mounting hardware included and one (1) pre-cut electrical access hole.
- Available in all high gloss, textured and two-tone finishes.

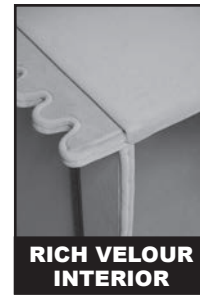

RICH VELOUR INTERIOR



SF6030 WITH NEW STANDARD STOR-IT PDO AND OPTIONAL STOR-IT CABINETS

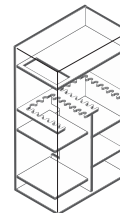
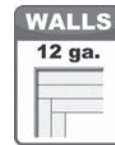
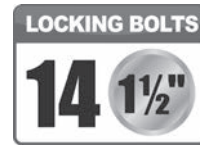

17-17-34 GUN INTERIOR
for Model: SF6036

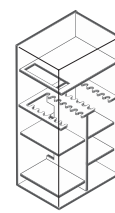

14-14-28 GUN INTERIOR
for Model: SF6030

COLOR OPTIONS:

High-Gloss Exterior Colors:
Hunter Green Metallic (HG),
Onyx (OX), Burgundy Metallic (BY),
Pearl (PW), Platinum Metallic (PL),
Charcoal Metallic (CM),
Macadamia Metallic (MM)

Textured Exterior Colors:
Granite (GR), Sandstone (ST),
Black (BK), Chocolate Brown (CB)

SF Two-Tone Finishes:
Onyx High-gloss door / Black Textured body
Charcoal High-gloss door / Granite Textured body

Any combination available on request

Model	Outside Dimension H x W x D	Thickness (Inches)		Interior Capacity	Wt. Lbs.
		Door Overall / Steel plate	Body		
SF6036	59" x 36" x 26"	4 1/4" / 1/4"	12 ga	17-17-34 + 2 Gun	850
SF6030	59" x 30" x 26"	4 1/4" / 1/4"	12 ga	14-14-28 + 2 Gun	706
SF6032	59" x 30" x 21"	4 1/4" / 1/4"	12 ga	9-9-18 + 2 Gun	648
SF5924	59" x 24" x 18"	4 1/4" / 1/4"	12 ga	8-8-16 Gun + 1 Gun	514

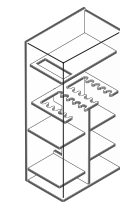

9-9-18 GUN INTERIOR
for Model: SF6032

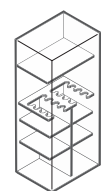

8-8-16 GUN INTERIOR
for Model: SF5924

Dimensions listed are exterior dimensions. Add 2" to overall depth for lock and handle.



FV SERIES - 45 MINUTE FIRE

GUN SAFES



FV7240E5



FV6030E5 WITH STOR-IT PDO



FV Series Safes Feature:

- 3/16" Steel Plate door with 2 layers of fire insulating material.
- Fire protection of 1200°F for 45 minutes. Designed to maintain an interior temperature of less than 350°F.
- 2 Stage Dual fire seals with silicone seal on door jamb and expandable Paluso™ seal on door.
- Body constructed of 12-gauge (FV7240E5 - 11ga) solid steel plate with a fire insulating material.
- Every FV Series gun safe comes standard with AMSEC's ESL5 Electronic Lock with illuminated keypad.
- Optional Group II combination lock available.
- Drill resistant hardplate with external spring-loaded re-locking device.
- New ultra smooth cam driven locking mechanism with increased handle rotation.
- 3-point chrome tri-spoke handle featuring slip clutch feature for additional security to prevent excessive torque to retract bolts during attempted break in. and bold zinc die-cast polished chrome logo.
- 4-way boltwork with 9 massive 1 1/4" chrome-plated locking bolts, and 5 deadbolts for a total of 14 bolts.
- Textured Black exterior and plush gray fabric interior.
- Premium Door Organizer (PDO). See Page 27 for more details.
- Four (4) pre-cut anchor holes with mounting hardware included and one (1) pre-cut electrical access hole.



GRAY FABRIC INTERIOR

Model	Outside Dimension H x W x D	Thickness (Inches)		Interior Capacity	Wt. Lbs.
		Door Overall / Steel plate	Body		
FV7240E5	72" x 40" x 26"	3 5/8" / 3/16"	11 ga	15-15-15-30-45 +2 Gun	954
FV6036E5	59" x 36" x 26"	3 5/8" / 3/16"	12 ga	17-17-34 +2 Gun	724
FV6030E5	59" x 30" x 26"	3 5/8" / 3/16"	12 ga	15-15-30 + 2 Gun	608
FV6032E5	59" x 30" x 21"	3 5/8" / 3/16"	12 ga	11-11-22 + 2 Gun	578

Dimensions listed are exterior dimensions. Add 2" to overall depth for lock and handle.

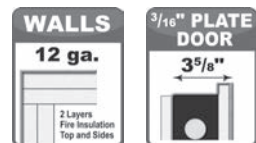
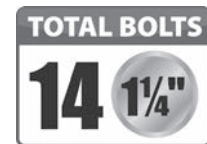

AMSEC GUN SAFE NO COST LIFETIME BURGLARY & FIRE REPLACEMENT WARRANTY:

- No Cost - Break-In Warranty
- No Cost - Attempted Break-In Warranty
- No Cost - Fire Warranty

See Our Gun Safe Catalog for more details.

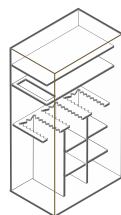

15-15-5-30-45 GUN INTERIOR
for Model: FV7240E5

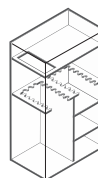

17-17-34 GUN INTERIOR
for Model: FV6036E5

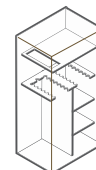

15-15-30 GUN INTERIOR
for Model: FV6030E5

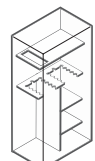

11-11-22 GUN INTERIOR
for Model: FV6032E5

TF SERIES - THIRTY MINUTE FIRE



LIFETIME WARRANTY
Against Theft & Fire
No Labor Charge
No Parts Charge
No Freight Charge

30 MINUTES
Fire Protection

TF5924E5 Features:

- 3/16" Steel Plate door with 2 layers of fire insulating material.
- Fire protection of 1200°F for 30 minutes. Designed to maintain an interior temperature of less than 350°F.
- 2 Stage Dual fire seals with silicone seal on door jamb and expandable Palusol™ seal on door.
- Body constructed of 14-gauge solid steel plate with a fire insulating material.
- AMSEC's ESL5 Electronic Lock with illuminated keypad.
- Optional Group II combination lock available.
- Drill resistant hardplate with external spring-loaded re-locking device.
- 3-point chrome tri-spoke handle featuring slip clutch feature for additional security to prevent excessive torque to retract bolts during attempted break in.
- Bold zinc die-cast polished chrome logo.

- 4-way boltwork with 9 massive 1 1/4" chrome-plated locking bolts, and 5 deadbolts for a total of 14 bolts.
- Adjustable ball bearing hinges.
- Premium Door Organizer (PDO). See page 27 for more details.
- Textured Black exterior and Mocha fabric interior.
- Four (4) pre-cut anchor holes with mounting hardware included and one (1) pre-cut electrical access hole.

The TF5517E5:

- 3/16" Steel Plate door with 2 layers of fire insulating material.
- Fire protection of 1200°F for 30 minutes. Designed to maintain an interior temperature of less than 350°F.
- 2 Stage Dual fire seals with silicone seal on door jamb and expandable Palusol™ seal on door.
- Body constructed of 14-gauge solid steel plate with a fire insulating material.

- AMSEC's ESL5 Electronic Lock with illuminated keypad, drill resistant hardplate and external spring-loaded re-locking device.
- Optional Group II combination lock available.
- Chrome "L" handle featuring slip clutch feature for additional security to prevent excessive torque to retract bolts during attempted break in.
- Bold zinc die-cast polished chrome logo.
- 4-way boltwork with 5 active 1" chrome-plated bolts and 3 deadbolts for a total of 8 bolts.
- Premium Door Organizer (PDO). See page 27 for more details.
- Textured Black exterior and Mocha fabric interior.
- Durable hinges.
- Four (4) pre-cut anchor holes with mounting hardware included and one (1) pre-cut electrical access hole.
- Warranty: 1 Year Parts and Labor.

TF5924E5

TOTAL BOLTS
14 1 1/4"

WALLS
12 ga.

3/16" PLATE DOOR
3 3/4"

TF5517E5

LOCKING BOLTS
8 1"

WALLS
14 ga.

3/16" PLATE DOOR
3 3/4"

Model	Outside Dimension H x W x D	Thickness (Inches)		Interior Capacity	Wt. Lbs.
		Door Overall / Steel plate	Body		
TF5924E5	59" x 24" x 18"	3 5/8 / 3/16	14 ga	8-8-16 Gun + 1 Gun	388
TF5517E5	55.25" x 17.34" x 16"	3 3/4 / 3/16	14 ga	11 Gun	286

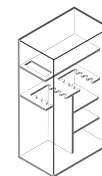

8-8-16
GUN INTERIOR
TF5924E5

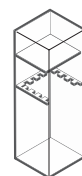

11
GUN INTERIOR
TF5517E5

Dimensions listed are exterior dimensions.
Add 2" to overall depth for lock and handle.



DEFENSE VAULT

DEFENSE VAULT



The AMSEC Defense Vault puts home security where you need it!

There's no better place to store your home-defense weapon within arm's reach than under your bed in the secure and easily accessible AMSEC Defense Vault!

The High Security electronic lock is easy to use, and in a matter of seconds, the door is open and the weapon is in hand!

Whether you currently have a safe or not, the Defense Vault should seriously be considered for any gun owner.

Features AMSEC's new ESL5 electronic lock with an illuminated keypad. Bright, backlit keys let you enter your PIN code, even in the dark.

The AMSEC Defense Vault is constructed of 14 ga. steel with a unique 5-point slide locking bar and features a foam-padded slide-out gun tray and 4 pre-cut anchor holes with mounting hardware.

Model	Outside Dimension H x W x D	Wt. Lbs.
DV652	6" x 52" x 14"	90
Tray Size	3 3/8" x 43 1/4" x 13"	

VAULT DOOR VD8030SF / VD8030BF

VAULT DOOR



Standard Features of The Vault Door:

- U.L. Listed Group II Lock with massive hard plate and two relocking devices.
- Spy-proof key-locking dial with matching five-spoke handle, pull handle and bold zinc die-cast logo. Available in polished brass, chrome or black nickel finish.
- 10 massive 1 1/2" chrome-plated bolts. (Note: no deadbolts required on In-Swing door)
- Select from four textured finishes.
- Commercial grade, Vault Door hinges.
- 2 Stage Dual fire seals with silicone seal on door jamb and expandable Palusol™ seal on door.
- New - Adjustable door frame slides together to fit a wall thickness of 4-3/4" to 9-3/4".
- Safety Lock Release: allows you to safely exit the vault room from inside. It also allows you to close and lock the door from the inside when equipped with an electronic lock, turning your vault into a safe room.

Special Features of the VD8030SF & VD8036SF:

- 2" thick door offers a defense barrier constructed of a 1/8" inner and 1/4" outer steel plates filled with a fire insulation material that provides a barrier against extreme heat.

Special Features of the VD8030BF & VD8036BF:

- 2" thick door offers a defense barrier constructed of a 1/2" steel plate door combined with 1-3/8" DryLight insulation that provides a barrier against extreme heat.

Model	Description	Wall Opening	Door Opening	Weight (Door Only)	Shipping Weight
VD8030SF	Vault Door	79 1/2" x 29 1/2"	77 1/2" x 24 3/4"	523	667
VD8030SFIS	In-Swing Vault Door		77" x 19 1/4"	505	649
VD8036SF	Vault Door	79 1/2" x 35 1/2"	77 1/2" x 31 3/4"	612	782
VD8036SFIS	In-Swing Vault Door		77" x 26 1/4"	575	745
VD8030BF	Vault Door	79 1/2" x 29 1/2"	77 1/2" x 24 3/4"	695	839
VD8030BFIS	In-Swing Vault Door		77" x 19 1/4"	672	816
VD8036BF	Vault Door	79 1/2" x 35 1/2"	77 1/2" x 31 3/4"	819	989
VD8036BFIS	In-Swing Vault Door		77" x 26 1/4"	792	962

VD8030BF/VD8030SF



VD8030BF



VD8030SF

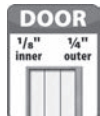

GUN SAFE ACCESSORIES AND OPTIONS



BATTERY OPERATED LIGHT KIT

This light fits any safe, yet gives off a super bright light, letting you see the contents of your safe easily. Battery operated.



PISTOL RACK

Ideal for organizing pistols inside your safe. This four gun pistol rack sits on top of an interior shelf.



.50 CALIBER HANDLE

Available in Black Nickel. 5-Spoke on BF® Gun Safe, 3-Spoke on SF Gun Safe.

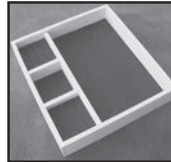

JEWELRY TRAY

Conveniently fits into every safe. Burgundy felt lined. 10-3/8" x 9-3/8" x 2"

LED LIGHT KITS

AMSEC introduces the new HIWL120 LED AC power light kit with built-in motion sensor. The HIWL120 has two 39" light strips with 120 high-intensity white LED's and a motion sensor that automatically turns itself on when motion is detected and turns itself off 30 seconds after you leave the area.

The new AMSEC HIWL120 LED AC power light kit can be installed on any AMSEC safe.



LED Light Kit



Motion Sensor

GUNSAVER DEHUMIDIFIER

Will constantly guard your guns against the threat of rust, pitting and moisture damage. Electrical access is required.

"AR" RACK

"AR" gun racks are fully adjustable and custom fit in the side shelf area of each "BF" series gun safe. Each rack is designed with enough clearance to accommodate extra large front sights or optics.



SLIDE-OUT WEAPONS STORAGE RACK

(BF® GUN SAFES ONLY)

This six-gun rack slides out for easy access to your firearms. Fits models BF7250, BF7240, BF6636 and BF6030.



DESSICANT

Prevents rust and moisture damage. Recommended for safes without electrical access.

PREMIUM UPGRADE PACKAGE FOR HS, BF® AND SF SAFES

When you choose to upgrade your HS, BF® or SF Series safe with a "Premium Package," we'll add on some of our most popular options including a jewelry tray, a Gunsaver dehumidifier and an LED light kit with power strip. (NOTE: No power strip will be supplied on BF Series safes with integrated internal power outlet).

HANDGUN SECURITY

NEW! PS1210HD Heavy-Duty Handgun Safe

Features:

- High strength 10 ga solid steel body.
- Massive 3/16 steel door with two solid steel dead bars and gas piston for easy opening.
- Welded and concealed continuous hinge.
- Reliable fast access Simplex push button mechanical locking device.
- Strong, pry-resistant locking bolt.
- Locking mechanism protected by steel housing, impervious to punch attacks.
- Charcoal gray textured finish with chrome hardware.
- Heavy-duty chrome carrying handle.



Protective high density pluck foam-lined interior. Four pre-drilled bolt down holes. Packaged for UPS/FedEx shipments. Made in the USA.

PB3 Handgun Safe

Features:

- Deep blue powder coated finish with chrome hardware.
- Heavy-duty chrome handle.
- Strong, pry-resistant chrome locking bolt.
- Interior cushioned with foam lining to protect against scratches.
- Easy to change combination with programmable override code.
- Four (4) AA batteries provides over 5,000 openings with low-battery indicator.
- Power override battery box included.

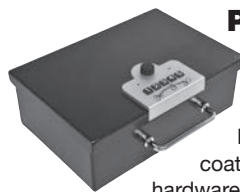

IRC412 Drawer Safe

Heavy duty steel construction offers excellent burglary protection. Convenient motorized locking system, incorporating the latest technology.



- Easy to read, large LED display lets you know the status of the safe.
- Reliable ADA approved keypad.
- 4 to 6 digit combination, standard hotel room configuration (customer sets new combination every time safe is used, quickly and easily), or electronic credit card.
- Lock-out penalty if the combination is entered wrong, the safe will lock up for 5 minutes, frustrating the would-be burglar.
- Emergency key-lock override system with 2 keys.
- Fits in a drawer and only requires 5" clearance
- Spacious interior fits tablets and compact lap top computers.

Exterior Dimensions	Weight
10.25" x 12.5" x 4.25"	24 lbs

Exterior Dimensions	Weight
8h x 12w x 4d	10 lbs

Exterior Dimensions	Weight
4.5 h x 12 w x 14 d	15 lbs



STOR-IT CABINETS

STORAGE OPTIONS

Stor-it Cabinets

These elegant, well-appointed **2-DRAWER AND 4-DRAWER INTERIOR CHESTS** are finely crafted in solid-wood maple drawer fronts and maple veneer and finished in a rich honey maple stain. Recessed door pulls give these cabinets a more streamlined appearance and makes for an easier fit into a variety of AMSEC safes. All drawers are elegantly lined in a silky, dark red felt with heavy-duty, ball-bearing drawer glides and include a variety of Stor-It Jewelry Organizer Inserts. Each insert can be removed for easy viewing, selecting and protection of your jewelry.

2-DRAWER OPTION:

- Top drawer includes a Three Compartment Ring Organizer and a Seven Compartment Jewelry Organizer. Bottom drawer can be used for bulky items or converts to a file drawer.
- Outside Dimensions: 16.5" x 15.875" x 14"
- Weight: 28 lbs.



4-DRAWER OPTION:

- Top drawer features a three compartment ring organizer and a seven compartment jewelry organizer. Drawer two features a three compartment necklace organizer. Drawer three features a four compartment watch organizer. Drawer four can be used for bulky items, or add more Stor-it Jewelry Organizers.
- Outside Dimensions: 16.5" x 15.875" x 14"
- Weight: 29 lbs.

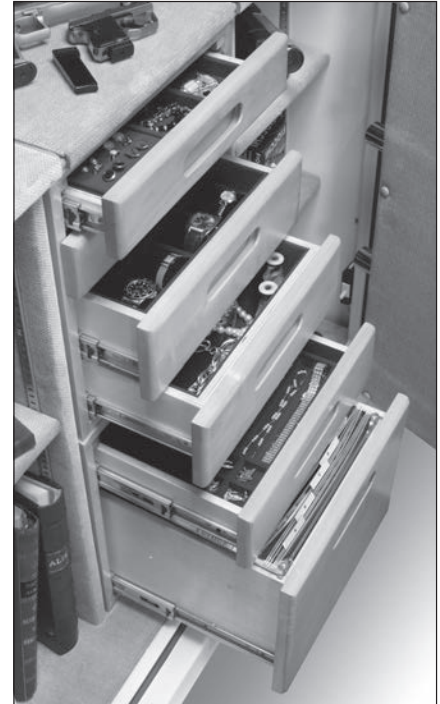

STOR-IT CABINETS ARE AVAILABLE IN THE FOLLOWING SAFE MODELS:

GUN SAFES: RF6528, RFX703620, RFX582820, BF7250*, BF7240, BF6636, BF6030, SF6036 and SF6030

BURGLARY/FIRE SAFES: BF1716* / BF3416*

CE AND CF MODELS: 2518* / 3524* / 5524* / 6528* / 7236*

CSC MODELS: CSC3018* AND CSC4520*

* No kit needed. Drawers slide right in.

PREMIUM DOOR ORGANIZER RETROFIT KITS

The AMSEC Premium Door Organizer (PDO) maximizes storage space, offers quick access to commonly used items, and are easily installed on any gun safe.

All PDO's include:

- Various see-through pouches and zippered pockets to store valuables.
- Two rows of holders for storage of choke tubes, small flashlights and ammo.
- Two full-width pistol storage systems to accommodate multiple handguns. Comes with four holsters. Additional holsters can be purchased separately.
- A long gun storage system that accommodates two guns. Includes the AMSEC exclusive "no hassle" quick release band.
- PDO Model 28 offers a zippered pocket large enough to store letter-size folders.



MODEL 13

MODEL 19

MODEL 28

AM SERIES HOME SECURITY SAFES



AM4020E5



AM2020E5

- Mocha fabric interior including back-cover and firewalls.
- Deep blue textured finish with bold, elegant American Security logo.
- Every AM Series home security safe now comes standard with AMSEC's ESL5 Electronic Lock with Illuminated Keypad, protected by a drill-resistant hard plate.
- Adjustable ball bearing hinges.
- High-strength unitized 12 ga. solid steel body.
- Massive 1 1/8" recessed door constructed of a 1/4" solid steel plate and a fire insulating material.
- 3-way boltwork with 5 active 1 1/4" diameter chrome-plated steel locking bolts (2020 Model has 4 active locking bolts).
- 4 pre-cut anchor holes with mounting hardware included.
- Fire protection of 1200°F for a period of 30 minutes. Designed to maintain an interior temperature of less than 350°F.
- Warranty: 1 Year Parts and Labor

Model	Outside H x W x D	Inside H x W x D	Cubic Inches	Thickness		Wt. Lbs.	Interior Shelves	Bolts
				Door	Body			
AM2020E5	20 x 20 x 20	17 x 18 1/4 x 14 1/2	4,710	1 1/2	12 ga	158	1	6
AM3020E5	30 x 20 x 20	27 x 18 1/4 x 14 1/2	7,402	1 1/2	12 ga	215	2	8
AM4020E5	40 x 20 x 20	37 x 18 1/4 x 14 1/2	10,094	1 1/2	12 ga	270	3	8

ELECTRONIC SECURITY SAFES



EST2014



EST813



EST916

EST813, EST916, EST1014, EST2014

Features:

- New State-of-the-art DL5000 electronic lock with a large 3 3/4" touch screen LCD input display allows smooth and easy operation.
- Mode altering display changes from orange in standby mode to bright blue in the open position.

- Accepts (2) user codes and can show open door records for the past 14 entries.
- LCD touch screen display shows low-battery indicator, time, date and keypad.
- Emergency key-lock override system with two (2) keys, power override battery box, built-in spy-proof function and motion detector alert.
- Heavy 14 gauge solid steel construction, plus dual live bolts made also of heavy gauge steel.
- Can be bolted to the wall or floor.
- Carpeted base.
- Pry-resistant recessed door with internal hinges for anti-theft protection.
- Mounting feet and anchor hardware standard.
- Models EST1014 and EST2014 have one removable shelf.
- Warranty: 1 year parts and labor.

Model	Inside Dimension H x W x D	Outside Dimension H x W x D	Clear Door	Cu. In. Capacity	Wt
EST813	7-11/16 x 12-13/16 x 5 1/2	7-7/8 x 13 x 7 3/4	5-5/8 x 9	498	16
EST916	8-13/16 x 16-11/16 x 12	9 x 16-7/8 x 14-1/8	6 3/4 x 13	1,765	30
EST1014	9-9/16 x 13-15/16 x 7 3/4	9 3/4 x 14-1/8 x 9 3/4	7-5/8 x 10 1/4	1,032	22
EST2014	19-9/16 x 13-9/16 x 10	19-3/4 x 13-3/4 x 12-1/4	17-1/8 x 9-1/4	2,602	40



IN-ROOM ELECTRONIC SAFES

ELECTRONIC SAFES

AMSEC's **IN-ROOM ELECTRONIC SAFE**, with its easy installation, maintenance and management features has become a popular safe in the hospitality industry. Designed with the traveling guests in mind, the IRC916E will adequately secure laptop computers, cameras, jewelry and other valuables in the most user-friendly safe made.



**ALSO AVAILABLE:
THE IRC412
DRAWER SAFE.
SEE PAGE 26
FOR MORE
INFO**

is entered wrong, the safe will lock up for 15 minutes, frustrating the would-be burglar.

- Emergency key-lock override system with 2 keys.
- Spacious interior fits most lap top computers.
- Two anchor holes with mounting hardware included.
- Attractive carpeted bottom hides anchor bolts.
- Electrostatic powder-coated finish in textured black.
- Guest instruction label included.
- Packaged for UPS shipment.

STANDARD FEATURES:

- Heavy duty steel construction offers excellent burglary protection.
- Convenient motorized locking system, incorporating the latest technology.
- Easy to read, large LED display lets you know the status of the safe.
- 4 digit combination, standard hotel room configuration (customer sets new combination every time safe is used, quickly and easily), or electronic credit card.
- Reliable ADA approved keypad.
- Runs on 4 AA batteries. If batteries should go dead, each safe has a by-pass power cable.
- Lock-out penalty if the combination

OPTIONS:

- Hand-held, programming device, offering audit trail and electronic override (IRCPROG).

Model	Inside Dimension H x W x D	Outside Dimension H x W x D	Clear Door	Cu. In. Capacity	Wt
IRC916E	8-13/16 x 15-13/16 x 12	9 x 16 x 14	6-9/16 x 13	1,672	29

ESF1214 FINGERPRINT SAFE



ESF1214

FEATURES:

- State-of-the-art fingerprint electronic lock.
- Motorized bolt work system with 2 chrome-plated solid-steel locking bolts.
- Spring-assisted door auto opens when unlocked.
- Laser-cut arched door design with heavy-duty 7/16" solid steel door and casing.
- 1/8" thick solid steel body.
- Attractive textured black finish.
- 1 adjustable shelf.
- Includes: 1 emergency key-lock with 2 keys and anchor kit.
- Large 1,692 cu. in. storage capacity.
- Warranty: 1 year parts and labor.

Model	Inside Dimension H x W x D	Outside Dimension H x W x D	Clear Door	Cu. In. Capacity	Wt
ESF1214	11.25 x 14.5 x 10.38	11.5 x 14.75 x 12.75	7.63 x 10.69	1,692	54



BLB AND BLC SERIES

AMSEC "B" AND "C" RATE SECURITY CHESTS are designed to provide secure storage at an economical price. In addition to meeting the requirements of the Insurance Offices Manual of Burglary Insurance, these units offer an appearance and many features similar to AMSEC'S higher rated TL-15 models.



BLC3018

STANDARD FEATURES

DOOR:

- 1" ("C" Rate), or ½" ("B" Rate) steel pry-resistant recessed door.
- U.L. listed Group II key changeable lock, with relock and 1 million possible combinations.
- Additional spring loaded reloading device, activated by a punching attack.
- Locks and relocks protected by a large carburized hardplate.
- A handle activated locking mechanism consisting of three 1" chromed steel locking bolts. (five in BLB and BLC4024 models).
- Solid steel full length dead bar prevents door removal if hinges are removed during a forced entry attempt.
- Adjustable ball bearing hinges.

BODY:

- ½" continuously welded ("C" rate) or 1/4" ("B" Rate) solid steel bodies.
- Body reinforcing frame gives the appearance of 1" thick walls to discourage attack.
- Adjustable shelves.
- Attractive Gray textured finish. Other colors available.
- Custom sizes, interior options and high security features available.
- Left swing door optional.

B-Rate Premium Free-Standing Security Chest

Model	Inside Dim H x W x D	Outside Dim* H x W x D	Clear Door H x W x D	Cu. In. Capacity	Wt	Shelves
BLB2018	20 x 18 x 12	20½ x 18½ x 15	18 x 16	4,320	218	2
BLB3018	30 x 18 x 16	30½ x 18½ x 19	28 x 16	8,640	312	2
BLB3024	30 x 24 x 20	30½ x 24½ x 23	28 x 22	14,400	360	3
BLB4024	40 x 24 x 20	40½ x 24½ x 23	38 x 22	19,200	445	4

*Add 2" to outside depth for handle, dial and hinge projection. Custom design available on request.

C-Rate Premium Free-Standing Security Chest

Model	Inside Dim H x W x D	Outside Dim* H x W x D	Clear Door H x W x D	Cu. In. Capacity	Wt	Shelves
BLC2018	20 x 18 x 12	21 x 19 x 16	18½ x 16½	4,320	370	2
BLC3018	30 x 18 x 16	31 x 19 x 20	28½ x 16½	8,640	550	2
BLC3024	30 x 24 x 20	31 x 25 x 24	28½ x 22½	14,400	740	3
BLC4024	40 x 24 x 20	41 x 25 x 24	38½ x 22½	19,200	925	4

*Add 2" to outside depth for handle, dial and hinge projection. Custom design available on request.



TL-15 & TL-30 MONEY CHESTS

DXE / DXF AND CDXE / CDXF U.L. LISTED

AMSEC TL-15 and TL-30 U.L. Listed **MONEY CHESTS** qualify for Mercantile & Broadform Insurance Class ER (TL-15) and F (TL-30) with a banking rating of BR (TL-15) and G (TL-30). AMSEC MONEY CHESTS offer the highest level of security available with many outstanding features and a wide range of options.



CDXE2020
TL-30 Composite
Body and
Plate Door



DXE1818
TL-15 Plate Body
and Door

FEATURES

DOOR:

- DXE and CDXE models are TL-15 rated constructed of 3/4" thick solid steel plate.
- DXF and CDXF models are TL-30 constructed of 1 3/4" thick laminated steel with a special hardened drill resistant plate.
- Oil impregnated bronze bearing hinges.

BODY:

- DXE models: Consist of 1/2" thick steel plate (100,000 P.S.I. minimum tensile strength). All external seams are beveled and continuously welded.
- DXF models: Models under 50" in height consist of 1/2" thick steel plate with 100,000 P.S.I. minimum tensile strength. DXF models over 50" in height constructed of 3/4" thick steel plate with 75,000 P.S.I. minimum tensile strength. All external seams are beveled and continuously welded.
- CDXE and CDXF models: consist of 3/4" thick body constructed of inner and outer steel plates enclosing a high density composite material.
- Shelf strips installed allowing shelf adjustment. Shelves optional.

LOCKING MECHANISM:

- U.L. listed Group II key changeable combination lock, with relock and 1 million possible combinations.
- Single auxiliary spring loaded relocking device, activated by a punching attack.

- Locks and relocks protected by a large proprietary drill shattering composite hardplate.
- A handle activated locking mechanism consisting of two to five 1" chromed steel locking bolts.
- Five boltwork sizes allow AMSEC to build units from 12" (10 1/2" for DXE/DXF) to 88" high, widths from 14" to 41".
- Solid steel dead bar prevents door removal if hinges are removed during a forced entry attempt.
- Compact locking mechanism and boltwork cover allow for optional door mounted coin racks.

HINGES:

- Fabricated from high strength steel with precision machined alloy dowel pins.
- Oil impregnated bronze bearing assures easy opening doors and reduced maintenance.
- Vertical height adjustment.

FINISH:

- Available in Satin Black, Parchment, Standard Gray, Blue Gray, Romanesque Gray, Charcoal Gray, Granite, Sandstone or Chocolate Brown textured finish.

OPTIONS:

- Spyproof dial
- Key lock dial
- Coin racks
- Managers lockers
- Interior lockers
- Interior drawers
- Adjustable shelves
- Group 1 and 1R locks
- Electronic locks
- Access Control Systems
- Key-Op locks
- Dual combination locks (some models)
- 144 hour timelock
- 15 minute time delay lock
- External day lock
- Claddings
- Anchor bolt assembly
- Left swing door
- Internal rotary hopper
- Internal deposit slot
- Internal deposit chutes
- Hidden compartments
- Modular alarm
- Hold up duress alarm
- Special sizes
- Custom colors

FOR A DETAILED CHART OF SIZES AND SPECS FOR THESE MODELS, PLEASE SEE THE AMSEC PRICE LIST, PAGE 12.



U.L. LISTED FIRE RATED MONEY CHEST

ACF TL-30 SERIES



**ACF4024
SHOWN WITH
AUXILIARY LOCK**

AMSEC TL-15 and TL-30 U.L. Listed **MONEY CHESTS** qualify for Mercantile & Broadform Insurance Class ER (TL-15) and F (TL-30) with a banking rating of BR (TL-15) and G (TL-30). AMSEC MONEY CHESTS offer the highest level of security available with many outstanding features and a wide range of options.

FEATURES:

DOOR:

- 5½" thick door constructed of outer and inner steel plates enclosing a high density proprietary composite material.
- Two hour, 350°F factory fire rating. Tested at temperatures up to 1850°F.

BODY:

- 3¼" thick body constructed of inner and outer steel plates enclosing a high density proprietary composite material.
- Door and inner jamb surrounded by thick solid steel bars.
- Adjustable shelves.

LOCKING MECHANISM:

- U.L. listed Group II key changeable lock, with relock and 1 million possible combinations.
- Single auxiliary spring-loaded reloading device, activated by a punching attack.

- Locks and relocks protected by a large proprietary drill shattering composite hardplate.
- A handle activated locking mechanism consisting of three to five 1" diameter chromed steel locking bolts.
- Five boltwork sizes allow AMSEC to build units from 12" to 82" high, widths from 18" to 48" (interior dimensions).
- Handle designed to shear in case of forced entry attempt.
- Solid steel dead bars prevent door removal if hinges are removed during a forced entry attempt.
- Compact locking mechanism allows for optional door mounted coin racks.

HINGES:

- Ball bearing hinges fabricated from high strength steel.
- Precision machined alloy dowel pins.
- Oil impregnated bronze bearing assures easy opening doors and reduced maintenance.
- Vertical height adjustment.

FINISH:

- Available in Satin Black, Parchment, Standard Gray, Blue Gray, Romanesque Gray, Charcoal Gray, Granite, Sandstone or Chocolate Brown textured finish.

OPTIONS:

- Spyproof dial
- Key lock dial
- Coin racks
- Managers lockers
- Interior lockers
- Interior drawers
- Adjustable shelves
- Group 1 and 1R locks
- Electronic locks
- Access Control Systems
- Key-Op locks
- Dual combination locks (some models)
- 144 hour timelock
- 15 minute time delay lock
- External day lock
- Anchor bolt assembly
- Left swing door
- Internal rotary hopper
- Internal deposit slot
- Internal deposit chutes
- Hidden compartments
- Modular alarm
- Hold up duress alarm
- Special sizes
- Custom colors
- Custom designs



Model	Inside Dimension	Outside Dimension*	Clear Door	Cu. In.	Wt
ACF 2020	20 x 20 x 20	26¾ x 26½ x 29	19 x 18¾	8,000	1,069
ACF 2020XD	20 x 20 x 24	26¾ x 26½ x 33	19 x 18¾	9,600	1,170
ACF 3020	30 X 20 X 20	36¾ x 26½ x 29	29 x 18¾	12,000	1,369
ACF 3020XD	30 X 20 X 24	36¾ x 26½ x 33	29 x 18¾	14,400	1,492
ACF 4024	40 X 24 X 20	46¾ x 30½ x 29	39 x 22¾	19,200	1,849
ACF 4024XD	40 X 24 X 24	46¾ x 30½ x 33	39 x 22¾	23,040	2,003
ACF 5024	50 X 24 X 20	56¾ x 30½ x 29	49 x 22¾	24,000	2,176
ACF 5024XD	50 X 24 X 24	56¾ x 30½ x 33	49 x 22¾	28,800	2,351
ACF 6030	60 X 30 X 20	66¾ x 36½ x 29	59 x 28¾	36,000	2,847
ACF 6030XD	60 X 30 X 26	66¾ x 36½ x 35	59 x 28¾	46,800	3,162

* Add 2" to outside depth for handle, dial and hinge projection. Standard with two shelves. Optional 3-way boltwork available on the ACF line, retail price \$160.00. Custom size/design quoted upon request.



AMVAULTx6 TL-30x6 HIGH SECURITY SAFE

AMVAULTx6 TL-30x6



The new Amvaultx6 U.L. Listed TL-30x6, six-sided high security composite safes are made in the United States using the latest 2011 testing procedures set forth by Underwriters Laboratories.

The new revolutionary Amvaultx6 is constructed with a 3" defense barrier of inner and outer steel plates enclosing a unique interlocking heavy duty steel barrier, high strength concrete exceeding 12,000 PSI and a high-density high-strength ceramic matrix.

The high density insulating materials incorporated in the door and body also insure two hours of certified fire protection. The superior design and craftsmanship make the new Amvaultx6 impervious to burglary attacks attempted by the most sophisticated equipment utilized today and the vaults contents against intense fires.



Model	Inside Dimension	Outside Dimension*	Clear Door	Cu. In.	Wt	Door Thickness	Shelves
CFX252016	25 x 20 x 16	31 x 26 x 25¼	25 x 20	4.6	1,433	6"	1
CFX352020	35 x 20 x 20	41 x 26 x 29¼	35 x 20	8.1	1,946	6"	2
CFX452020	45 x 20 x 20	51 x 26 x 29¼	45 x 20	10.4	2,343	6"	3
CFX582820	58 x 28 x 20	64 x 34 x 29¼	58 x 28	18.8	3,418	6"	4
CFX703620	70 x 36 x 20	76 x 42 x 29¼	70 x 36	29.2	4,578	6"	4

* Add 2" to outside depth for handle, dial and hinge projection.
Optional 3-way boltwork available on the CFX line, retail price \$160.00.

U.L. LISTED FIRE RATED DEPOSITORY SAFE



ACF4824DS

AMSEC's ACF TL-30 **TWO DOOR DEPOSITORY SAFE** offers complete cash management versatility for any operation that requires a nonreturnable deposit such as armored car companies, convenience stores, restaurants, etc. The U.L. listed TL-30 composite construction offers peace of mind when overnight protection is required.

In addition to the outstanding features listed under ACF TL-30 Money Chest, the ACF4824DS Depository safe also offers:

TOP DEPOSIT / STORAGE COMPARTMENT

- Outer door equipped with a U.L. listed Group II combination lock and chrome plated front read dial.
- Large storage capacity: accommodates up to nine cash register trays.
- Large 3" x 18" deposit chute is protected by an "anti-fish", saw-tooth, hinged baffle.
- Two adjustable shelves.
- Door mounted four-opening rolled coin storage rack.

Options:

- Electronic locks, Group 1 and 1R locks.
- Dual combination locks (Receiving compartment only).
- Spyproof dial, Keylock dial.
- Modular alarm, Holdup alarm.
- Interior lockers, Interior drawers, Adjustable shelves.
- Custom sizes/designs quoted upon request.
- Access Control Systems.

BOTTOM RECEIVING COMPARTMENT

- Outer door equipped with a U.L. listed Group II combination lock, chrome plated front read dial and an auxiliary key-op lock for dual control or armored car pick up.

FINISH

- Available in Satin Black, Parchment, Standard Gray, Blue Gray, Romanesque Gray, Charcoal Gray, Granite, Sandstone or Chocolate Brown textured finish.



Model	Inside Dimension	Outside Dimension*	Clear Door	Cu. In.	Wt
ACF4824DS	TOP 26 x 18 x 14 BTM 14 x 18 x 17	47¾ x 24½ x 26	25 x 16¾ 13 x 16¾	6,552 4,284	1746

* Add 2" to outside depth for handle, dial and hinge projection. Standard with two shelves.
Optional 3-way boltwork available on the ACF line, retail price \$160.00. Custom size/design quoted upon request.

ACF TL-30 SERIES



FIRE RATED COMPOSITE SAFES

During extreme testing procedures, **AMVAULT COMPOSITE SAFES** demonstrated the ability to withstand severe attacks by experienced U.L. experts using powerful tools such as sledgehammers, power saws, carbide disc cutters, drills, etc., and without fail, were awarded the U.L. TL-15 and TL-30 labels.

Besides withstanding the most concentrated attacks by sophisticated burglars, each AMVAULT safe offers a Two Hour, 350° F factory fire test certification, ensuring the protection of the vault's contents against intense fires.



CF3524



CE2518 WITH OPTIONAL STOR-IT CABINET (PG 45)

OPTIONAL STOR-IT CABINETS AVAILABLE IN CE AND CF MODELS:
2518 / 3524 / 5524 / 6528 / 7236

Fully upholstered safe interior kits available for these models.
 See Page 27 for more details.



CF6528 SHOWN WITH OPTIONAL INTERIOR LOCKERS

1850°

AMVAULT 2-Hour, 350° F rating (Factory tested at 1850°)

1200°

Average House Fire

450° F

Paper Chars

350° F

Interior of an AMSEC Safe



FEATURES:

DOOR:

- Overall thickness of 6" and is constructed with a 3" defense barrier of outer and inner steel plates creating a single structure enclosing a unique, high density fire and burglary resistant composite material.
- Defense barrier houses a proprietary amalgamation of nuggets and steel fibers to withstand concentrated attacks with the most sophisticated equipment used by burglars today.

BODY:

- The AmVault formed body has a total protective thickness of 3½" enclosing a high density fire resistant composite material with nuggets and steel fibers.
- A reinforced drill resistant door frame protects the door and each individual bolt chamber from severe side attacks.
- A proprietary inner barrier protects against peeling attacks.
- High strength adjustable shelves.

FIRE ENDURANCE:

- Two hour, 350°F factory fire rating. Tested at temperatures up to 1850°F

LOCKING MECHANISM:

- Equipped with six to ten massive 1½" diameter chrome plated solid steel locking bolts. Each bolt moves deep into the body's protected bolt chambers.
- Entire boltwork mechanism is also protected by a spring operated boltwork detent system. Bolts stay in the retracted position when the door is opened and automatically engage when the door is closed.

THREE-WAY BOLTWORK OPTION (TL-30 ONLY):

- Safes can be equipped with a three way active boltwork mechanism engaging the bolts horizontally and vertically into the body of the safe.

LOCKS:

- Equipped with a U.L. listed Group II key changeable combination lock. The lock is protected by a massive drill shattering hard plate and two additional spring-loaded devices.

HINGES:

- Offers a vertical height adjustment and utilizes an oil impregnated bearing ensuring easy door operation.

OPTIONAL AUXILIARY KEY LOCK:

- U.L. listed, high security auxiliary key lock is also available on all AMVAULT safes (except Model 1814). Lock is equipped with 2 keys and escutcheon plate.
- An additional spring-loaded relock device protecting lock against punch attacks.

OPTIONAL GLASS RELOCKING MECHANISM (TL-30 ONLY):

- Incorporated into the AMVAULT TL-30 auxiliary key lock is an optional high security tempered glass relock mechanism with a remotely and randomly placed "cross locking" relocking bolt and thermal cords to protect against torch attacks.
- In the event of an attack by tools, torches, or explosives, the glass will shatter activating the highly sophisticated relock mechanism.
- Utilizing the glass relock mechanism can offer up to a total of six different relock devices offering the ultimate in high security protection.

OPTIONAL PREMIUM UPGRADE PACKAGE AVAILABLE

When you choose to upgrade your safe with a "Premium Package," we'll add on some of our most popular options including a jewelry tray, dehumidifier and an LED light kit with power strip.



SAFE SPECIFICATIONS

AMVAULT TL-30 AND TL-15

AMVAULT High Security Composite safes have passed Underwriter's Laboratories most recent testing procedures ensuring you today's best protection. AMVAULT TL-15 and TL-30 U.L. listed composite safes qualify for Mercantile & Broadform Insurance Class ER (TL-15) and F (TL-30) with a Bank Rating of BR (TL-15) and G (TL-30). Two Hour Class 350°F manufacturers' fire label. Standard finish is Parchment. Other colors available on request.

Model Number	Inside Dimension	Outside Dimension*	Cubic Feet	Weight	Interior Shelves	Door Swing		
	H x W x D	H x W x D				A	B	C
TL-15								
CE1814**	18 x 14 x 12	25 x 21 x 21½	1.8	710	1	14	36	39½
CE2518	25 x 18 x 16	32 x 25 x 25½	4.2	1,105	1	18	44	47½
CE3524	35 x 24 x 20	42 x 31 x 29½	9.7	1,674	2	24	56	57½
CE4524	45 x 24 x 20	52 x 31 x 29½	12.5	2,003	3	24	56	57½
CE5524	55 x 24 x 20	62 x 31 x 29½	15.3	2,343	3	24	56	57½
CE6528	65 x 28 x 20	72 x 35 x 29½	21.1	3,153	4	28	64	61½
CE7236	72 x 36 x 23	79 x 43 x 32½	34.5	3,880	4	36	80	72½
TL-30								
CF1814**	18 x 14 x 12	25 x 21 x 21½	1.8	725	1	14	36	39½
CF2518	25 x 18 x 16	32 x 25 x 25½	4.2	1,195	1	18	44	47½
CF3524	35 x 24 x 20	42 x 31 x 29½	9.7	1,908	2	24	56	57½
CF4524	45 x 24 x 20	52 x 31 x 29½	12.5	2,311	3	24	56	57½
CF5524	55 x 24 x 20	62 x 31 x 29½	15.3	2,679	3	24	56	57½
CF6528	65 x 28 x 20	72 x 35 x 29½	21.1	3,359	4	28	64	61½
CF7236	72 x 36 x 23	79 x 43 x 32½	34.5	4,426	4	36	80	72½

* Add 2" to outside depth for handle, dial and hinge projection.
 **Models 1814 can not be equipped with an auxiliary lock, 3-way boltwork or glass relock mechanism. Left Swing Models: After model #, use suffix L.



CUSTOM AMVAULT ESCUTCHEON PLATE
 Shown with optional auxiliary key lock and pull handle, with matching operating handle.
 *Tri-spoke handle standard on all models.

DOOR SWING PROJECTIONS

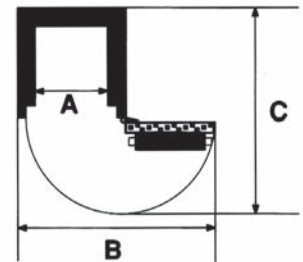

UNDERWRITERS LABORATORIES' BURGLARY RATING CLASSIFICATION

U.L. Label — Burglary Classification TL-15:

Signifies a combination-locked safe designed to offer a limited degree of protection against attack by common mechanical and electrical hand tools and any combination of these means.

Construction Requirements

- U.L. listed Group II, 1 or 1R combination lock.
- 750 lbs. minimum or comes with instructions for anchoring in a larger safe, concrete blocks or on the premises where used.
- Body walls of material equivalent to at least 1" open hearth steel with a minimum tensile strength of 50,000 P.S.I.
- Walls fastened in a manner equivalent to continuous ¼" penetration weld of open hearth steel with minimum tensile strength of 50,000 P.S.I.

- One hole ¼" or less, to accommodate electrical conductors arranged to have no direct view of the door or locking mechanism.

Performance Requirements

Successfully resist entry* for a net working time of 15 minutes when attacked with common hand tools, picking tools, mechanical or portable electric tools, grinding points, carbide drills and pressure applying devices or mechanisms.

U.L. Label —Burglary Classification TL-30:

Signifies a combination-locked safe designed to offer a moderate degree of protection against attack by common mechanical and electrical hand tools and any combination of these means.

Construction Requirements

Same as TL-15



Performance Requirements

Successfully resist entry* for a net working time of 30 minutes when attacked with common hand tools, picking tools, mechanical or portable electric tools, grinding points, carbide drills and pressure applying devices or mechanisms, abrasive cutting wheels and power saws.

*Entry=Safes classed as TL-15 — opening the door or making a six square inch opening entirely through the door or front face. Safes classed as TL-30 — opening the door or making a six square inch opening entirely through the door or front face.



PHARMACY AND NARCOTICS SAFES



PSSW-38



PSSW-38
WITH ADDITIONAL SHELF AND
TWO OPTIONAL DRAWERS



PSE-28



PSK-28

AMSEC's complete line of **PHARMACY AND NARCOTICS SAFES** offer a great solution for keeping your high-value, high-target medications and facility safe from the devastating occurrence of a robbery, burglary or internal theft. Choose from several models that are ideal for small to larger sized pharmacies, hospitals or health care facilities.

Pharmacy Safe Features:

- AMSEC Pharmacy safes are designed to easily replace a standard large or small wooden pharmacy cabinet.
- Standard Pharmacy safes come in two sizes with three depths to choose from. Custom size available upon request.
- Large safes have an outside dimension of 77" H x 36 1/4" W with a 12", 18" or 24" depth.
- Small safes have an outside dimension of 38 1/2" H x 36 1/4" W with a 12", 18" or 24" depth. Small safes are designed to fit under the counter or can be stacked and bolted together to create a 4 door taller unit.
- Two outer doors made of high strength steel with six heavy duty hinges (4 in smaller safes) and a two-way locking system.
- Each safe comes with 5 adjustable shelves (2 in smaller safes). Additional shelves available.
- Optional drawers available to securely store back stock of (CII) controlled drugs. Each drawer is equipped with 12 adjustable compartments, heavy-duty ball bearing suspension glides and is secured by the lock of your choice.
- Each safe is provided with 4 anchor holes and hardware to secure it to the floor.
- Available in Pharmacy White textured finishes. Custom colors available.
- Approx. weight for Tall Safes: 613 lbs to 866 lbs. Approx. weight for Small Safes: 379 lbs to 487 lbs.
- Made in the USA.

NS Series Narcotic Safe Features:

- 1/2" thick solid steel recessed door, and formed, high-tensile steel body and reinforced jambs on all four sides to maximize protection against pry and sledgehammer attacks.
- Roll-out narcotic drawers with removable dividers provide easy-to-organize access to (CII) controlled drugs. Made in the USA.
- Locks and relocks protected by a large carburized hardplate and an auxiliary spring-loaded relock device.
- 3-way locking mechanism consisting of five massive 1" diameter chromed steel locking bolts.
- Bolt detent system keeps bolts retracted when the door is open and then automatically engages when door is shut.
- Door mounted storage compartments.
- Four anchor bolt holes with hardware.
- Available in Black or Pharmacy White textured finishes.



NS3020W

Pharmacy & Narcotic Safe Lock Options:

- PSSW Pharmacy safes offer the SafeWizard Electronic lock. A full featured Access Control System that controls the outer door and up to 5 interior drawers, 40 users, programmable time delay, time lock, full audit feature and remote connectivity. For more information see page 41.
- PSAudit Pharmacy safes offer the ESLAudit Electronic lock. A robust Access Control System that controls the outer door and 1 interior drawer, 40 users, programmable time delay, time lock and a full audit feature. For more information see page 42.
- PSE Pharmacy safes offer the ESL20XL Electronic lock. Controls the outer door, 8 users and programmable time delay. For more information see page 43.
- PSK Pharmacy safes offer a high security Medeco key lock that controls the outer door. Only offered on Pharmacy safes.
- Other lock options available upon request.



For a detailed chart of sizes and specs for these models, please see the AMSEC Price List, Page 13.



TELLER LOCKERS

TELLER LOCKERS



FEATURES:

Body:

- 16"H x 32-5/8" W x 24" D, 1/4" solid steel construction.

Door:

- 1/4" solid steel, hinged from center, divider.

Hinge:

- Solid steel continuous hinge.

Color:

- Available in Satin Black, Parchment, Standard Gray, Blue Gray, Romanesque Gray, Charcoal Gray, Granite, Sandstone or Chocolate Brown textured finish.

Locks:

- U.L. listed double nose and single nose safe deposit locks or Medeco® camlocks standard. Combination locks optional extra.

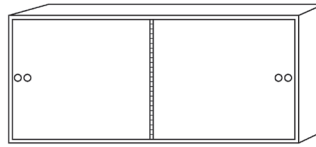

ATL-2
WEIGHT: 240 LBS.

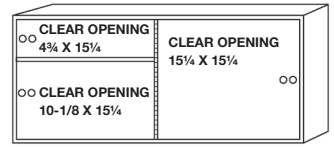

ATL-3R
WEIGHT: 255 LBS.

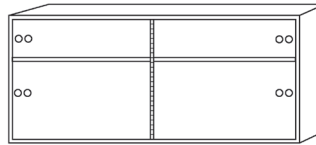

ATL-4
WEIGHT: 270 LBS.

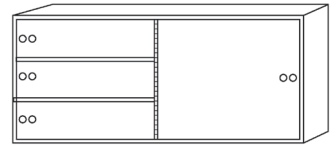

ATL-4R
WEIGHT: 270 LBS.

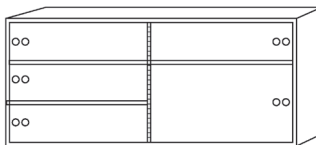

ATL-5R
WEIGHT: 285 LBS.

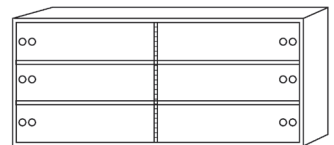

ATL-6
WEIGHT: 295 LBS.

CUSTOM SAFES

CUSTOM SAFES

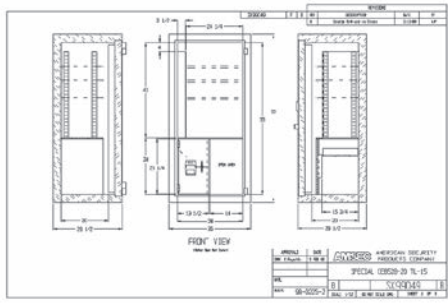

AMSEC specializes in manufacturing CUSTOM SAFES for supermarkets, banks, restaurants, convenience stores, gas stations, hotels, mini-marts and other businesses. With over 50 years experience building custom safes, AMSEC has the knowledge and expertise to design a safe to meet your cash handling requirements. Our engineering department is equipped with the latest in computer-aided design (CAD) systems for rapid creation of detailed sales sketches, concept drawings, final product prints and design modifications to help you visualize how the safe will look and function. Custom safes are available in every insurance classification from "B" Rate to U.L. listed TL-30 models.

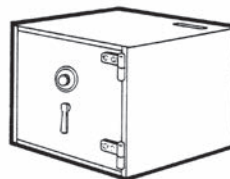
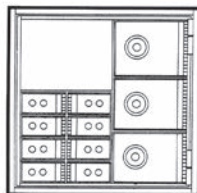
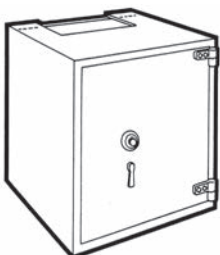
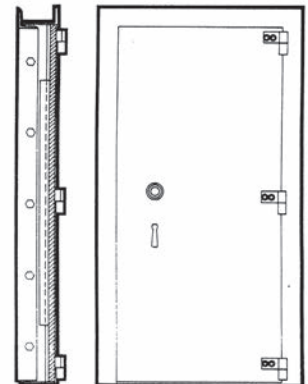
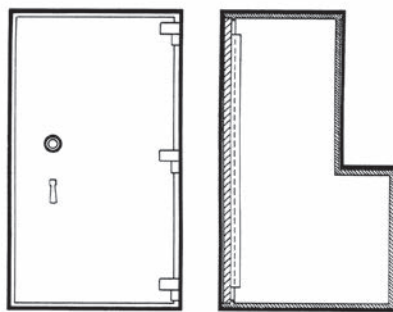
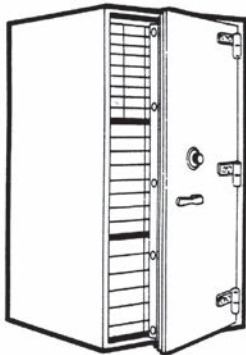

OPTIONAL EXTRAS



Interior Drawers

All drawers are commercial quality, heavy steel construction. Available in letter, legal and document sizes. Each is furnished with handle and key lock. All drawer capacities are 150 lbs. and come with a heavy duty latch removable ball bearing suspension.

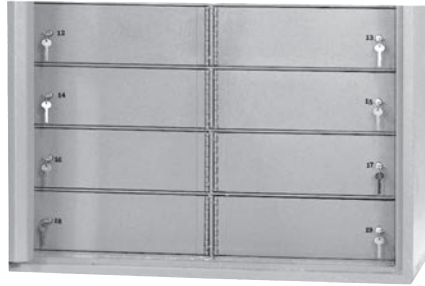

Interior Lockers

AMSEC offers a wide variety of standard interior locker compartments to fit your needs. Standard lockers are constructed of 10 gauge or 1/4" solid steel. Options include slotted doors, combination locks and high security key locks.

SUPER BRUTE "B" AND "CB" RATE SQUARE HINGED DOOR



Slotted Doors

Slotted doors are also available on freestanding plate safes, freestanding clad, composite chests, interior lockers and interior drawers.

Note: Safes with slotted doors are not recommended for overnight storage.



STAR "C" RATE SLOTTED ROUND DOOR
with 3/8" x 3 1/2" slot



MINI BRUTE "B" RATE SQUARE LIFT-OUT DOOR

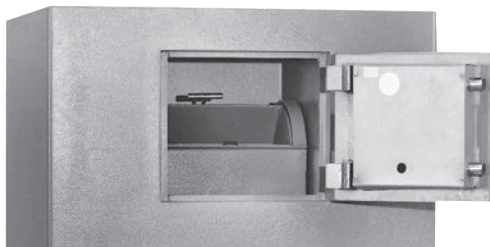

Interior/Exterior Hopper

Available in three different package sizes ranging from 5 3/4" D x 3 1/2" W x 8 3/4" L to 7" D x 4 1/2" W x 10 3/4" L.

Hoppers can be installed on the interior or exterior of plate, clad or composite safes.



Modular Alarm System

Detects vibration, heat and door openings. Heat indicator activates alarm when torch attack occurs. Internal magnetic door contact detects door opening. Internal vibration sensor activates alarm if safe is moved or during drill attack.

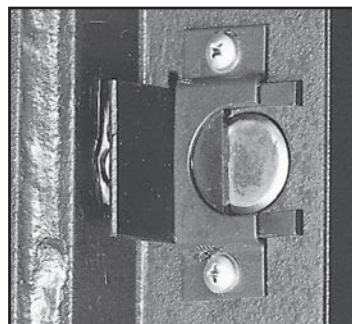

Locking Bolt Detent

Keeps locking bolts retracted when door is in open position. Prevents damage to safe body and boltwork mechanism caused by accidental door closure with bolts extended.



Coin Racks

For organized storage of coins. Mounted on inside safe door. Available with four or six compartments.



MECHANICAL LOCKS AND KEY LOCKS

MECHANICAL LOCKS AND KEY LOCKS

AMSEC offers a wide variety of options not listed here. Consult your AMSEC price book or call for other available options. AMSEC's staff will also assist in helping you choose the correct options for your security needs.



U.L. Listed Group 2 Mechanical Combination Safe Lock Kit

Mechanical Combination Safe Locks have been around for over 100 years and are very secure and reliable. With the proper care and service, the AMSEC mechanical combination safe lock will last a long time.

Features:

- Three brass and aluminum combination wheels provide 1,000,000 theoretical combinations.
- Dual brass locking cams prevent wheel slippage.
- Solid brass locking bolt and zinc drop lever.
- Four-way brass drive cam allows mounting RH, LH, VU or VD.
- Internal spring-loaded brass relock trigger guards against punch attacks.
- Standard mounting footprint matches most mechanical and electronic safe locks.
- Large front-read convertible dial and ring.
- Both dial and ring are die cast with black finish and white letters.
- A solid, machined brass spindle – 4 7/8"
- Can be converted to a key-locking dial with a disc tumbler key cylinder and two keys (shown at right).
- Comes standard with an attractive self-stick solid dial insert or a key-locking dial insert.

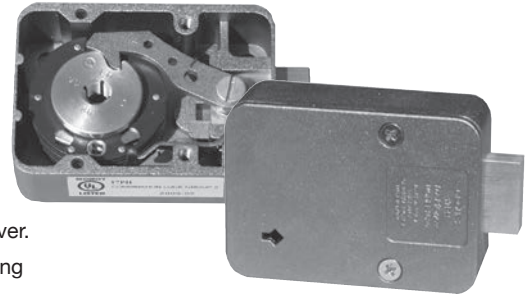

Safe Lock Kit Includes:

- U.L. Listed Group 2 mechanical safe lock.
- Large front-read convertible dial & ring, B/W finish.
- Non-key-locking dial insert.
- Key-locking dial insert.
- Key cylinder and two keys.
- Package mounting hardware and two spline keys.
- Combination change key.
- Durable packaging and foam inserts protect contents from shipping damage.



Spyproof Dial

Restricts unauthorized viewing while dialing combination. Also available with key locking feature.



Key Locking Front Read Dial

Key is used to lock dial in a fixed position and affords dual custody control. Manager has the combination, collector has the key. Both must be present to unlock the safe.



144 Hour Time Lock

Safes equipped with Time Locks offer the capability of locking the safe for a pre-selected period of time. Time periods range from one hour to 144 hours (6 full days).

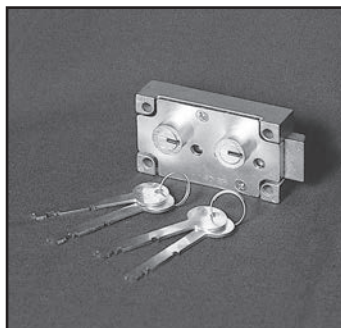

U.L. Listed Dual Nose Key Lock

Dual control safe deposit lock requires two different keys to open safe.

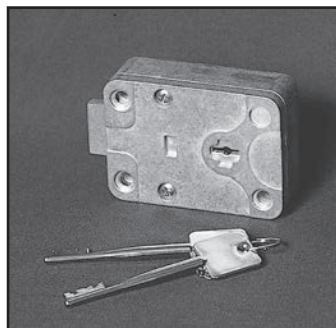

U.L. Listed Key Op Lock

European style seven-lever changeable key lock offers exceptional security features for use on inner locker or outer safe doors.

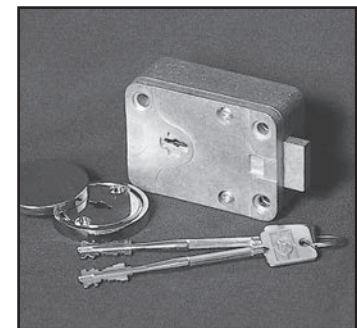

U.L. High Security Key Lock

European style nine-lever changeable key lock offers exceptional security features for use on inner locker or outer safe doors.

ELECTRONIC LOCK COMPARISON CHART



Feature	AMSEC		ESL15		ESL10XL		ESL20XL		SafeWizard®		ESL Audit		Lock DUO		6120		6123		6126		Titan		Basic		ComboCard		AuditCard		SmartLine		AuditCon 52		AuditCon 252		AuditCon 552		
	Round Backlit	Pending U.L.	Round Backlit	Pending U.L.	Round	Type 1	Round	Type 1	Round	Type 1	Horizontal Rectangle	Vertical Rectangle	Round w/ Combo Back Up	Round	Type 1	Round	Type 1	Round	Type 1	Round	Type 1	Round	Type 1	Round	Type 1	Round	Type 1	Round	Type 1	Round	Type 1	Round	Type 1	Round	Type 1		
Keypad Housing																																					
U.L. Listed	Pending U.L.	Pending U.L.	Pending U.L.	Pending U.L.	Type 1	Type 1	Type 1	Type 1	Type 1	Type 1	Pending U.L.	Type 1	Type 1	Type 1	Type 1	Type 1	Type 1	Type 1	Type 1	Type 1	Type 1	Type 1	Type 1	Type 1	Type 1	Type 1	Type 1	Type 1	Type 1	Type 1	Type 1	Type 1	Type 1	Type 1	Type 1		
Number of Users	1	1 Master 8 Users	1	1 Master 8 Users	1 Master 8 Users	40- Multiple User Opts. Reg. Mgr.- Mgr.- Mgr. & Std Users	1 w/ 3 number Combo Back Up	1	1	1	40- Multiple User Opts. Reg. Mgr.- Mgr.- Mgr. & Std Users	40- Multiple User Opts. Reg. Mgr.- Mgr. & Std Users	1 w/ 3 number Combo Back Up	1	1	1	1	1	1	1	1	1	1	1	1	1	1	1	1	1	1	1	1	1	1	1	1
Time Delay Override	NO	YES	YES	YES	YES	YES	YES	YES	YES	YES	YES	YES	N/A	NO	NO	NO	NO	NO	NO	NO	NO	NO	NO	NO	NO	NO	NO	NO	NO	NO	NO	NO	NO	NO	NO	NO	
Safe Doors	1	1	1	1	1	6 / 1 deposit	2	1	1	2	2	1	1	1	1	1	1	1	1	1	1	1	1	1	1	1	1	1	1	1	1	1	1	1	1	1	
Power Source	(1) 9V No A/C Opt	(2) 9V / No A/C Opt	(2) 9V / AC (Opt.)	(2) 9V / AC (Opt.)	(2) 9V / AC (Opt.)	AC with Battery Back-up	(2) 9V / AC (Opt.)	(1) 9V No A/C	(2) 9V	(2) 9V / AC (Opt.)	(2) 9V / AC (Opt.)	(1) 9V No A/C	(1) 9V No A/C	(2) 9V	(2) 9V	(2) 9V	(2) 9V	(2) 9V	(2) 9V	(2) 9V	(2) 9V	(2) 9V	(2) 9V	(2) 9V	(2) 9V	(2) 9V	(2) 9V	(2) 9V	(2) 9V	(2) 9V	(2) 9V	(2) 9V	(2) 9V	(2) 9V	(2) 9V	(2) 9V	
Combination (number of digits)	6	6	6	6	6	Key +6 8 if Keypad only Fingerprint +6	Key +6 8 if Keypad only	6	6	6	Key +6 8 if Keypad only	6	6	6	6	6	6	6	6	6	6	6	6	6	6	6	6	6	6	6	6	6	6	6	6	6	
Wrong Try Lock Out (time)	YES (15 min.)	YES (15 min.)	YES (15 min.)	YES (15 min.)	YES (15 min.)	Settable (user only)	YES (15 min.)	N/A	N/A	N/A	YES (15 min.)	N/A	N/A	4 (15 min.)	4	5 (10 min.)	5 (10 min.)	4 (15 min.)	4	4	4	4	4	4	4	4	4	4	4	4	4	4	4	4	4	4	
Dual Mode	N/A	YES	YES	YES	YES	YES	Yes	N/A	N/A	Yes	Yes	N/A	N/A	NO	NO	YES	YES	YES	YES	YES	YES	YES	YES	YES	YES	YES	YES	YES	YES	YES	YES	YES	YES	YES	YES	YES	
Time Delay	N/A	1-99 min.	N/A	N/A	1-99 min.	1-99 min.	1-99 min.	N/A	N/A	1-99 min.	1-99 min.	N/A	N/A	1-9 min.	1-9 min.	1-99 min.	1-99 min.	1-99 min.	1-99 min.	1-99 min.	1-99 min.	1-99 min.	1-99 min.	1-99 min.	1-99 min.	1-99 min.	1-99 min.	1-99 min.	1-99 min.	1-99 min.	1-99 min.	1-99 min.	1-99 min.	1-99 min.	1-99 min.	1-99 min.	
Time Delay Open Input Window (time/by user)	N/A	1-9 min.	N/A	N/A	1-9 min.	1-99 min.	1-99 min.	N/A	N/A	1-99 min.	1-99 min.	N/A	N/A	2 min./ fixed	2-9 min.	1-10 min.	1-10 min.	2-9 min.	1-10 min.	1-10 min.	1-10 min.	1-10 min.	1-10 min.	1-19 min.	1-19 min.	1-19 min.	1-19 min.	1-19 min.	1-19 min.	1-19 min.	1-19 min.	1-19 min.	1-19 min.	1-19 min.	1-19 min.	1-19 min.	
Time Lock (periods) (variable)	N/A	N/A	N/A	N/A	N/A	(6) (*)	(4) (*) Software set	N/A	N/A	N/A	N/A	N/A	N/A	N/A	N/A	N/A	N/A	N/A	N/A	N/A	N/A	N/A	N/A	N/A	N/A	N/A	N/A	N/A	N/A	N/A	N/A	N/A	N/A	N/A	N/A	N/A	
Duress	N/A	N/A	N/A	N/A	N/A	STD	Opt	N/A	N/A	Opt	Opt	N/A	N/A	OPT	OPT	OPT	OPT	OPT	OPT	OPT	OPT	OPT	OPT	OPT	OPT	OPT	OPT	OPT	OPT	OPT	OPT	OPT	OPT	OPT	OPT	OPT	
Audit Trail (# of events)	N/A	N/A	N/A	N/A	N/A	YES 8000 w/ 500 Backup Time & Date	YES 2000 Time & Date- Software Viewed	N/A	N/A	YES	YES	N/A	N/A	N/A	N/A	YES 400 Time & Date	YES 512 Time & Date	N/A	N/A	N/A	N/A	N/A	N/A	N/A	N/A	N/A	N/A	N/A	N/A	N/A	N/A	N/A	N/A	N/A	N/A	N/A	N/A
PC Software Audit Records	N/A	N/A	N/A	N/A	N/A	(OPT)	(OPT)	N/A	N/A	(OPT)	(OPT)	N/A	N/A	NO	NO	(Opt) Audit Only	(Opt)	(Opt)	(Opt)	(Opt)	(Opt)	(Opt)	(Opt)	(Opt)	(Opt)	(Opt)	(Opt)	(Opt)	(Opt)	(Opt)	(Opt)	(Opt)	(Opt)	(Opt)	(Opt)	(Opt)	(Opt)
Alarm Interface	N/A	N/A	N/A	N/A	N/A	YES	Opt.	N/A	N/A	Opt.	Opt.	N/A	N/A	NO	NO	YES	YES	NO	NO	NO	NO	NO	NO	NO	NO	NO	NO	NO	NO	NO	NO	NO	NO	NO	NO	NO	NO
Bolt Options Auto Lock	YES	YES	YES	YES	YES	YES	YES	N/A	N/A	YES	YES	N/A	N/A	YES	YES	YES	YES	YES	YES	YES	YES	YES	YES	YES	YES	YES	YES	YES	YES	YES	YES	YES	YES	YES	YES	YES	YES
Spring Bolt/ Stair Bolt	N/A	N/A	YES	YES	YES	YES	YES	N/A	N/A	YES	YES	N/A	N/A	YES	YES	NO	NO	YES	YES	YES	YES	YES	YES	YES	YES	YES	YES	YES	YES	YES	YES	YES	YES	YES	YES	YES	YES



AMSEC SAFEWIZARD®

ELECTRONIC LOCKS

The **SafeWizard®** electronic safe controller is a state-of-the-art electronic product for use in controlling and auditing access to safes. Designed to prevent burglaries and internal theft, the **SafeWizard®** controls and documents each access to the safe. Based on contemporary high speed processors, unique user friendly software techniques and ingenious application ideas, this system surpasses all other safe access control systems.

FEATURES:

- A powerful processor based on the ColdFire® 32 bit microprocessor.
- Flash Memory for quick and cost effective upgrades.
- Up to 10,000 audit entries and 40 users.
- Controls both outer and inner doors.
- Time Delay any door with a 1-99 minute delay and 1-99 minute open period with cancel feature.
- Time Lock any door, 1-6 windows per day.
- Authentication options: PIN code and/or Dallas Key access control, optional Finger Print Reader or Card Swipe devices are available.
- Wrong Try Count Penalty Lockout.
- Auto-Purge Idle Users option, selectable by Individual User.
- Forced PIN Changes to decrease risk of compromised PINs.
- Armored Car courier Time Delay and Lock Bypass.
- Duress/Hold-up Alarm with Silent Signal.
- Burglary Alarm output triggering from selectable events.
- Holiday Schedule with up to 16 programmable events per year.
- Automatic Daylight Savings Adjustment, selectable and configurable.
- Dual Control Mode on any individual door, selectable by user.
- Built-in key maker, complete with management tool set, audit trail sorting by several criteria.
- Deposit Tracking system to provide the highest level of cash management security.
- Communications possibilities are unrivaled. Incorporating Multiple Serial Devices, optional Ethernet Networking Port. Audits and administration can be managed through the Serial Port of Personal Computer or remotely via a Network connection.
- Audit utility allows PC based audit storage management, data filter and sorting capabilities and excellent exception reporting to focus on key security issues.
- Ultra-high contrast 8 line by 21 character graphics display.
- Rechargeable Battery Backup.
- Built-in System Diagnostics.
- Alarm Interfaces in the Power Supply Module interfaces the system to any conventional Alarm System, with simple connections for Alarm Output, Duress Output, CCTV Activation and an Input for Alarm System control of the **SafeWizard** system.
- Parallel Printer Interface.
- English, Spanish, French and German language options.



SafeWizard®

New WizAdmin Remote Communication Features

- With the optional Ethernet Networking Port (NMPS) and the WizAdmin remote safe access software, audits and administration can be accessed remotely via a network connection.
- Remote operators are assigned a USB security key and predetermined user authority level (UAL) facilitating administration at any desired level.
- Enroll unlimited safes in any time zone and maintain a full configuration record.
- Safe Audits: Provide date, time, event and user filtering capability.
- Safe User: Administer individual user profile list as well as modify, add or delete functions.
- Safe Locks/Doors: Administer all access control perimeters.
- Exception Event: Provides e-mail notifications of selected safe activity.
- Group Administration: Group multiple safes to a region or city and allows group administration changes to be applied as a single action.
- Print Summary Report: Provides a list of enrolled safes and basic information.
- Print Safe Detail: Provides detailed safe configuration report with time delay, time lock, holiday schedules, etc.
- Reboot Controller: Allows a remote system reset.
- Other Remote Administration Functions: Set safe clock, time delay settings, duress, pin reject mode, repeating holidays and much more!

THE AMSEC SAFEWIZARD ELECTRONIC ACCESS CONTROL SYSTEM IS AVAILABLE ON NEW AMSEC SAFES OR AS RETROFIT KITS.

Authentication Options:



DALLAS KEYS



FPC FINGERPRINT READER

Accessories:



DOOR SENSOR
Monitors door position (standard on external doors)



SAFEGUARD
Protects controller against accidental damage

NEW! ESLAUDIT



Every business, large or small, can benefit from an easy to use safe access control system. **AMSEC'S ESL AUDIT ELECTRONIC LOCK** makes it easy to manage safe access with its integrated USB Port and user-friendly PC application. Download lock settings, Upload lock settings, Download audit trail, Upload software upgrades and More! In addition, all functions can be securely shared via email.

ESLAUDIT FEATURES:

- Upgrades made easy! Retrofits most mechanical or electronic safe locks.
- Ultra-high-contrast 4 lines by 21 characters graphics display.
- 2,000 audit records.
- 40 users with unique security privileges.
- PC application for managing lock & administration setup.
- Audit utility allows PC-based audit storage management, data filter and sorting.
- USB interface for quick and cost-effective software upgrades, audit downloads and lock administration setup.
- Powered by two 9-volt batteries or optional power supply.
- Alarm interface in power supply with connections for alarm output or duress.
- Controls 1 or 2 doors.
- Safe doors can be configured in any inner/outer arrangement.
- Time delay any door with a 1-99 minute delay and 1-99 minute open period with cancel feature.
- Time lock any door, 1-6 windows per day.
- Authentication options: PIN code and/or Dallas Key access control.

- Wrong try count & penalty lockout.
- Armored car (courier) bypass for time delay and time lock.
- Holiday schedule with up to 16 programmable events per year.
- Automatic daylight savings adjustment, selectable and configurable.
- Dual control mode on any individual door, selectable by user.
- Warranty: One year parts, labor and support.
- Built-in system diagnostics.
- MakePIN: a proprietary application that allows for factory-supported administration.



ESLAUDIT LATCH LOCK

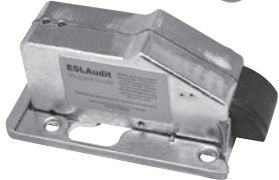

ESLAUDIT TOGGLE LOCK



ESLAUDIT POWER SUPPLY



ESLAUDIT SWINGBOLT LOCK

ESL5 AND ESL15

AMSEC is a pioneer in the electronic lock market, and the **NEW ESL SERIES** offers unrivaled value in electronic safe access. The ESL5 and ESL15 locks have the best blend of features and function in electronic safe locks. The ESL5 offers attractive chrome or black rubberized finish ABS housing with a backlit alphanumeric keypad. The ESL15 offers durable black rubberized finish ABS housing with an alphanumeric keypad. The ESL5 is a basic keypad lock for home and office applications. The ESL15 offers advanced features necessary for commercial applications.



ESL5 & ESL15 FEATURES:

- Replaces most mechanical combination locks. Easy installation and operation.
- ESL5 has an attractive chrome or black rubberized finish ABS housing with a backlit alphanumeric keypad.
- ESL15 has a durable black rubberized finish ABS housing with an alphanumeric keypad.
- Factory Reset Combination for resolving lost combinations without requiring expensive service calls.

- Electronics are encapsulated within the lock and are sealed to prevent possible moisture-related failures.
- Cable fits through a 1/2" spindle hole without cutting and re-crimping connector.
- Beep and flash from every keystroke gives maximum feedback to the user.
- Lock can be programmed to silence the beep in stealth mode.
- 15-Minute Penalty Lockout after four incorrect entries protects against manipulation attempts.
- New swing bolt reversible lock design for right- or left-handed installation.
- Lock "auto-locks" when boltwork is thrown to prevent safes from being left in a day-lock position.

- One 9-volt battery can be easily replaced in the keypad housing.
- Pending U.L. Type 1 listing.

ESL15 ADDITIONAL FEATURES:

- Time Delay Mode allows delay to be set from 1 to 99 minutes.
- Armored Car Override allows an armored car service to bypass Time Delay.
- Multiple User Mode allows for one master code and eight user codes to be used for full supervisory control and code management.
- Dual Control Mode programs the lock to require two combinations to open.



AMSEC ESLXL SERIES

ELECTRONIC LOCKS



**ESL10XL
WITH BRASS FINISH**

**ESL10XL
FEATURES:**

- Replaces most mechanical combination locks. Easy installation and operation.
- Factory Reset Combination for solving lost combinations without requiring expensive service calls.
- Electronics are encapsulated within the lock and are sealed to prevent possible moisture related failures.
- Cable fits through a 1/2" spindle hole without cutting and re-crimping connector.
- Audible beep and flash from every keystroke gives maximum feedback to the user.
- 15 minute Penalty Lockout after four incorrect entries protects against manipulation attempts.
- New patented dead-latched lock design with an internal relock device for maximum security.
- Lock "auto-locks" when boltwork is thrown to prevent safes from being left in a day lock position.
- Slam Bolt version for locker applications.
- Optional internal battery pack extends operation between battery changes.

AMSEC has been a pioneer in the electronic lock market. The **ESLXL SERIES** locks offer unrivaled value in electronic safe access. The ESL10XL and ESL20XL locks have the best blend of features and function in Electronic Safe Locks. The ESLXL SERIES offer an attractive metal die-cast keypad housing with an alpha-numeric slanted keypad. The ESL10XL is a basic keypad lock for home and office applications. The ESL20XL offers advanced features necessary for commercial applications.

**ESL20XL
ADDITIONAL FEATURES:**

- Time Delay Mode: Delays can be set from 1 to 99 minutes.
- Multiple User Mode: When enabled, one Master code and eight user codes are available with full supervisory control and code management.
- Dual Control Mode: The lock can be programmed to require two combinations to open for added security.
- Armored Car Override: When enabled, allows an armored car service to bypass Time Delay.
- External A/C Power: Provides power for unlimited use with battery power as backup.
- Control Port: Turn the ESL20XL on/off with an Alarm System or other device.

Optional Expansion Modules:
Provides these additional capabilities on the ESL20XL:

- Duress (Silent Signal) Alarm Output. Provides relay output for alarm system connection.
- External connection for A/C power transformer on ESL20XL and ESL10XL.
- External connection for control port.
- Provides for connection of one or two ESL20XL locks.



**ESL20XL
WITH BLACK FINISH**

All the ESL20XL features are programmed from the keypad. The Expansion Modules provide convenient screw terminal and slip spade connections for field wiring by the installer.

A/C Power can be connected to the ESL10XL and ESL20XL lock (with the ESLAC kit) or an Expansion Module (with the ESLTFMR kit). Wiring, conduit and attachment hardware is provided with all optional kits.

Model	Description	Finish
ESL10XL	ESL10XL Standard Lock	Black Nickel, Chrome, Brass
ESL10XL-S	ESL10XL Slam Bolt Lock	Black Nickel, Chrome, Brass
ESL20XL	ESL20XL Standard Lock	Black
ESL20XL-S	ESL20XL Slam Bolt Lock	Black

* Lock factory installed in place of the standard Mechanical Combination Lock, Dial and Dial Ring.

** Lock factory installed as an auxiliary lock, includes all mount pads and hardware for installation. Please refer to our Retail Price List for a complete list of part numbers for primary lock, auxiliary lock and Retrofit kit options.

Accessory Number	Description
ESLBAT	Aux. Battery pack for any ESL Locks. Provides extended life on battery power.
ESL20XLEXP1	Expansion Kit for (1) ESL20XL lock. External box with duress capability.
ESL20XLEXP2	Expansion Kit for (2) ESL20XL locks. External box with duress capability.
ESLAC	A/C Power kit for use with any ESL lock. Provided with conduit and fasteners.
ESLTFMR	A/C Transformer for use with any Expansion Kit.

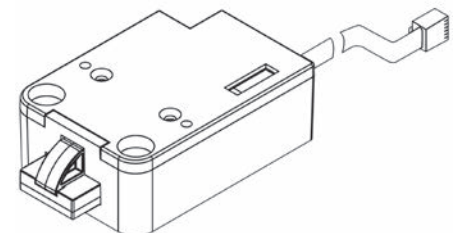

SLAM BOLT

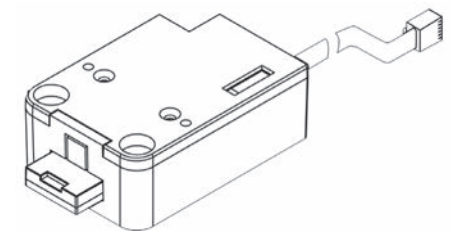

STANDARD BOLT

SARGENT AND GREENLEAF



SARGENT AND GREENLEAF
A lock on security.

For detailed specifications,
visit www.sglocks.com



S&G Titan™



S&G 6120



S&G 6120
Biometric Lock



S&G 6123-303



S&G 6126
Audit Lock

KABA-MAS



For detailed specifications,
visit www.kaba-mas.com



AUDITCON®
ROUND PROFILE

LAGARD ELECTRONIC SAFE LOCKS



For detailed specifications
on LaGard locks,
visit www.kaba-mas.com



LG BASIC II



SAFEGARD



SMARTLINC



MATERIALS HANDLING EQUIPMENT

MATERIALS HANDLING EQUIPMENT

Provide a higher level of service to your customer with AMSEC's new line of **MOVING EQUIPMENT**, giving you the capability to deliver and install any size safe -- quickly and safely!



LIFT 'N' ROLL MODEL 1500NR



Lift 'N' Roll

- Load is always stable and balanced.
- The hydraulic rams allow easy raising and gentle lowering of load from 1/8" to 4 1/2".
- Non-marking polyurethane wheels and padding system.
- Two handles on each side provide ease of maneuvering.
- Lightweight design. Built to last.
- Sturdy steel construction.
- Capacities up to 1,500 lbs.

UltraLift Powered Hand Truck

Designed to meet your on-the-job requirements, the UltraLift is the best move you will ever make. Machine weight includes strap bar, 4-wheel dolly and spill-proof gel cel battery. Minimum overall machine height is with extension handle retracted for moves in restricted areas. Maximum height is with handle fully extended for maximum leverage:

- Great versatility: Handle any load on the level, up and down the stairs, on and off trucks, over obstacles and many more.
- Light-weight aluminum stands up to years of rough use.

- The operator stays in control by using a combination of motor power, balance and leverage.
- One person can easily handle every load, even up and down the stairs, reducing labor costs.
- Gentle handling eliminates bumps and bounces to loads and premises, eliminating damages.
- Pay-off is approximately 21 installs (based on a national average of \$200 per install).
- Load capacity up to 1,500 lbs. Machine weight is 120 lbs.
- Optional accessories available. See AMSEC's Retail Price Book.



ULTRALIFT MODEL 1500UL

Triple L Trailer

The design of this patented, innovative trailer is the result of Premco's extensive engineering and testing procedures. Triple L Trailers offer the highest quality and best value of any trailer on the market!

Features:

- Heavy duty tubular chassis - steel diamond deck plate supported by 4 tubular members running the full length of the deck to give complete wheel support for heavy loads.

- Level loading - deck remains level through out raising and lowering.
- Full width rear ramp angle allows easier loading.
- Hydraulic System activated by a single lever.
- Oversized deck bearings rated for 80,000 lbs. - each bearing greaseless and sealed.
- Automatic latch locks upon raising for added travel security.
- Battery, pump and motor are enclosed in a lockable compartment.

- Lockable tool box - ideal for storing chain binders, tie down straps, etc.
- Heavy duty adjusting tongue jack.
- Lights Standard.
- Charcoal powder coated finish.
- 1 Year Manufacturers Warranty.

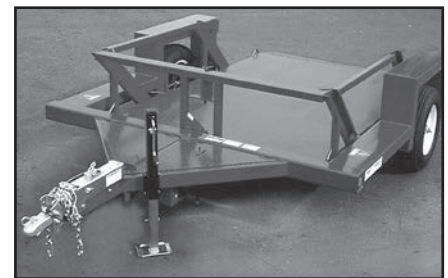

MODEL 4610

Model	248	4610	7610
Capacity	2200	4500	7000
Deck Size	4' x 8'	6' x 10'	6' x 10'
Overall Width	80"	101"	101"
Lift Mechanism	Winch	Hydraulic	Hydraulic
Axle	Single	Single	Tandem
Suspension	Torsion	Spring	Spring
Wheel Size	15"	14.5"	15"
Brakes	No	Electrical	Electrical
Hitch (Ball Size)	2"	2"	2-5/16"
Weight	1,510 lbs.	2,070 lbs.	2,500 lbs.



LOAD



LIFT

* Specification and design are subject to improvement and may change at any time without notice.



MERCHANDISING / DISPLAYS

AMSEC PROMO PACKS

PART #	DESCRIPTION
1045008	3-PACK SAFES: WS1014K, WFS149E5LP, & WS1214E5 Also includes display stand, POP, product tags, color poster and consumer brochures. Save \$190.00
1045020	4-PACK PROMOTIONAL KIT: safe pedestal, sales banner, 3 hanging signs, safe usage poster, window decal, consumer brochures, product tags, & authorized dealer certificate. Save \$80.00
1045021	8-PACK PROMOTIONAL KIT: Two safe pedestals, sales banner, 4 hanging signs, safe usage poster, window decal, consumer brochures, product tags, & authorized dealer certificate. Save \$75.00

AMSEC INDIVIDUAL SALES AIDS

PART #	DESCRIPTION
1045014	Display Pedestal
1045000	Sales Banner (5ft w x 3ft h)
1045024	"Burglary/Fire Safes" Hanging Sign (21"w x 10"h)
1045028	"Fire Safes" Hanging Sign (21"w x 10"h)
1045029	"Floor Safes" Hanging Sign (21"w x 10"h)
1045030	"Depository Safes" Hanging Sign (21"w x 10"h)
1045134	"Wall Safes" Hanging Sign (21"w x 10"h)
1045133	"Gun Safes" Hanging Sign (21"w x 10"h)
1015241	Authorized Dealer Window Decal
1045073	Guide to Safe Usage Poster (24"w x 18"h)
4305127	Retail Price List
4305128	Guide to All Products Brochure (color 4 x 9)
1045129	Dealer Catalog
4305172	Gun Safe Brochure
4305222	Gun Safe Mini-Brochure
1045072	Gun Safe Warranty Poster (24"w x 18"h)
1045076	BF® Gun Safe Authorized Dealer Banner (5ft w x 3ft h)
1045058	BF® Door Cutaway Plaque
1045071	BF® Body Cutaway Plaque
4305174	Warranty/Operating Booklet
1045004	Magnetic Price Tags (4 x 6) - Pack of 6
1045007	3 pack display only
1045201	PDO Display Kit with PDO, Stand and Straps included
1045202	PDO Display Stand - Stand Only



ELECTRONIC SAFE DISPLAY RACK
PART #1045161



3-PACK DISPLAY RACK
PART #1045007



DISPLAY PEDESTAL
PART #1045014



BF® SAFE BODY CUTAWAY
PART #1045071



BF® SAFE DOOR CUTAWAY
PART #1045058



SALES BANNER
5FT W X 3FT H
PART #1045000



PDO DISPLAY KIT
PART #1045201

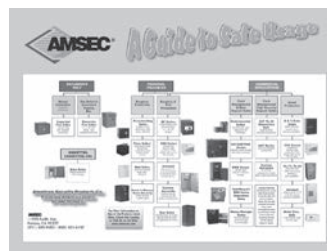

SAFE USAGE POSTER
(24"W X 18"H)
PART #1045073



MAGNETIC PRICE TAGS (PACK OF 6)
PART #1045004



GUN SAFE CATALOG
PART #4305172



PRODUCT CATALOG
PART #1045129



RETAIL PRICE LIST
PART #4305127



ALL PRODUCT BROCHURE
PART #4305128



GUN SAFE "MINI" BROCHURE
PART #4305222



"BURGLARY / FIRE SAFES" HANGING SIGN (21" W X 10" H)
PART #1045024

MERCANDISING / DISPLAYS



INDEX BY MODEL NUMBER

INDEX BY MODEL NUMBER

A

ACF 2020 32

ACF 2020XD 32

ACF 3020 32

ACF 3020XD 32

ACF 4024 32

ACF 4024XD 32

ACF4824DS 33

ACF 5024 32

ACF 5024XD 32

ACF 6030 32

ACF 6030XD 32

AM2020E5 28

AM3020E5 28

AM4020E5 28

B

B6 7

B17 7

B24 7

B400 5

B1500E5 5

B1806 5

B1810 5

B1816 5

B1816D 5

B2200E5 5

B2900E5 5

B3700E5 5

B3800E5 5

B5800E5 5

BD24 7

BDP24 7

BF1512 18

BF1716 18

BF2116 18

BF3416 18

BF6024 21

BF6030 21

BF6032 21

BF6636 21

BF7240 21

BF7250 21

BLB2018 30

BLB3018 30

BLB3024 30

BLB4024 30

BLC2018 30

BLC3018 30

BLC3024 30

BLC4024 30

BR2212x1 11

BR2212x1PP 11

BR2213x2 11

BR2213x2PP 11

BR3112x1 11

BR3112x1PP 11

BR3113x2 11

BR3113x2PP 11

BR3122x2 11

BWB2020 15

BWB2020FL 12

BWB2020FLNL 12

BWB2020FLR 12

BWB2020FLRNL 12

BWB2025 15

BWB2025FL 12

BWB2025FLR 12

BWB3020 15

BWB3020-D1 12

BWB3020FL 12

BWB3020FLR 12

BWB3025 15

BWB3025FL 12

BWB3025FLR 12

BWB4020 15

BWB4020FL 12

BWB4020FLR 12

BWB4025 15

BWB4025FL 12

BWB4025FLR 12

C

C3 6

C5 6

C7 6

CD5 6

CD7 6

CDXE 31

CDXF 31

CE1814 35

CE2518 35

CE3524 35

CE4524 35

CE5524 35

CE6528 35

CE7236 35

CF1814 35

CF2518 35

CF3524 35

CF4524 35

CF5524 35

CF6528 35

CF7236 35

CFX252016 33

CFX352020 33

CFX452020 33

CFX582820 33

CFX703620 33

CSC1413 19

CSC1913 19

CSC3018 19

CSC4520 19

D

DSC2014KC 13

DSF2014 13

DSF2714 13

DSF2731 13

DSF3214 13

DSR2014 13

DST2014 13

DST2714 13

DST2731 13

DST3214 13

DV652 25

DXE 31

DXF 31

E

ESF1214 29

ESL5 42

ESL10XL 43

ESL15 42

ESL20XL 43

ESLAUDIT 42

EST813 28

EST916 28

EST1014 28

EST2014 28

F

FS149 16

FS149E5LP 16

FS712E5LP 16

FS914 16

FS914E5LP 16

FS1814E5 16

FS2215 16

FV6030E5 23

FV6032E5 23

FV6036E5 23

FV7240E5 23

I

IRC412 26

IRC916E 29

K

K-1 / K-2 8

L

LG BASIC II 44

M

MM2820Ctr-Drop-E15 . 14

MM2820Top-Drop-E15 14

MM28203-Drop-E15 . 14

MS1414 15

N

NS3020 36

P

PB3 26

PS1210HD 26

PSAUDIT 36

PSE 36

PSK 36

PSSW 36

R

RF6528 20

RFX582820 20

RFX703620 20

RMM2620ESL15-R . . . 9

RMM2620ESLAudit-R . . 9

RMM2620SW-R 9

S

SAFEGARD 44

SF5924 22

SF6030 22

SF6032 22

SF6036 22

SMARTLINC 44

T

T425 7

T625 7

T625DD 7

T925 7

T925DD 7

TB0610 8

TF5517E5 24

TF5924E5 24

U

UL1511 17

UL1812 17

UL1812X 17

UL2018 17

UL3918 17

V

VD8030BF 25

VD8030BFIS 25

VD8030SF 25

VD8030SFIS 25

VD8036BF 25

VD8036BFIS 25

VD8036SF 25

VD8036SFIS 25

W

WEST2114 3

WFS149 3

WFS149E5LP 3

WS1014 3

WS1014K 3

WS1214E5 3

DOCUMENTS ONLY

Stamp Collection
(moisture protection)

Tax Returns Insurance Papers, Etc.

Imported Fire Safes
(U.L. 1 hr. 350°F rating minimal burglary protection)

Domestic Fire Safes
(U.L. 2 hr. 350°F rating minimal burglary protection)

See Pg. 16

See Pg. 17

PERSONAL VALUABLES

Burglary Protection

Burglary & Fire Protection

Freestanding Safes
(BWB Series, BLB Series, MS1414)

BF® Series
(True burglary and fire protection. U.L. 1 hr. 350°F fire rating.)

See Pg. 15 & 30

See Pg. 18

Floor Safes*
Brute/Super Brute Round Door
*Excellent fire protection if properly installed in concrete.

See Pg. 4-7

CSC Series
Commercial Security Safes
(Passed a 1 hr., 350°F factory fire certification)

See Pg. 19

Wall Safes
(WS1014, Heavy Duty WS1214)

See Pg. 3

Amvault High Security TL-15 / TL-30
Recommended for \$20,000 and above. 2 hr.1850°F fire test.

See Pg. 34-35

American Security Home Safes
(Home security & pistol safes)

See Pg. 26 & 28

Custom Amvaults
(Interior can be customized with lockers and drawers)

See Pg. 37

Vault Door
(Standard and in-swing door openings)

See Pg. 25

Gun Safes
(Revolutionary BF Series, High Security HS Series and Affordable SF, FV & TF Series)

See Pg. 20-24

Defense Vault
(Under Bed Safe)

See Pg. 25

COMMERCIAL APPLICATIONS

Cash Management B-Rate Deposit Safes

Cash Management High Security Deposit Safes

Asset Protection

Undercounter Safes
(Install under cash register for till trimming)

See Pg. 8

ACF TL-30 Depository Safe
(High Security Overnight protection)

See Pg. 33

B & C Rate Safes
(BWB, BLB, BLC, custom sizes & interiors available)

See Pg. 15 & 30

DST/DSF/DSR Series
(Deposits made through top, front or reverse)

See Pg. 13

ACF Series
(Can be completely customized)

See Pg. 32-33

CSC Series Commercial Security Safes
(Passed a 2 hr., 350°F factory fire certification)

See Pg. 19

BWB Series
(B-rate wide body for cash tray storage)

See Pg. 12

Custom Amvaults
(TL-15, TL-30, customize int. w/inside drops, lockers and drawers)

See Pg. 37

TL-15, TL-30
(DXE, DXF, CDXE, CDXF, ACF custom interiors and sizes available)

See Pg. 31-32

SafeWizard® Access Control & CashWizard Depository Safes

See Pg. 10-14

Amvault High Security TL-15, TL-30 & TL-30x6.
Custom Interiors available)

See Pg. 33-35

Money Manager Series
(Immediate deposits personnel shift accountability)

See Pg. 14

Pharmacy/Narcotics Safes

See Pg. 36

RMM Series
(C-Store Cash Management Safe)

See Pg. 9

In-Room Electronic Safes
(User friendly, high security safe)

See Pg. 29

GUIDE TO SAFE USAGE

American Security Products Company

11925 Pacific Ave.,
Fontana, CA 92337
Phone: 951-685-9680
Toll Free: 800-421-6142
Fax: 951-685-9685
Email: info@amsecusa.com
www.amsecusa.com

HIGH GLOSS COLORS

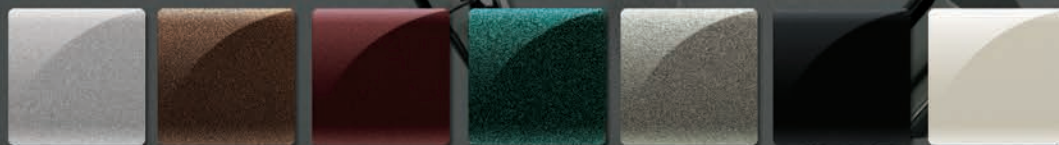

PLATINUM METALLIC

MACADAMIA METALLIC

BURGUNDY METALLIC

HUNTER GREEN METALLIC

CHARCOAL METALLIC

ONYX

PEARL

TWO-TONE COLORS



GRANITE / CHARCOAL

BLACK / ONYX

TEXTURED COLORS



SATIN BLACK

GRANITE

SANDSTONE

CHOCOLATE BROWN

PARCHMENT

ROMANESQUE GRAY

GRAY

BLUE GRAY

CHARCOAL GRAY